

User's Guide

Keysight
N9923A
FieldFox Analyzer

Warranty Statement

The material contained in this document is provided "as is," and is subject to being changed, without notice, in future editions. Further, to the maximum extent permitted by applicable law, Keysight disclaims all warranties, either express or implied with regard to this manual and any information contained herein, including but not limited to the implied warranties of merchantability and fitness for a particular purpose. Keysight shall not be liable for errors or for incidental or consequential damages in connection with the furnishing, use, or performance of this document or any information contained herein. Should Keysight and the user have a separate written agreement with warranty terms covering the material in this document that conflict with these terms, the warranty terms in the separate agreement will control.

DFARS/Restricted Rights Notice

If software is for use in the performance of a U.S. Government prime contract or subcontract, Software is delivered and licensed as "Commercial computer software" as defined in DFAR 252.227-7014 (June 1995), or as a "commercial item" as defined in FAR 2.101(a) or as "Restricted computer software" as defined in FAR 52.227-19 (June 1987) or any equivalent agency regulation or contract clause. Use, duplication or disclosure of Software is subject to Keysight Technologies' standard commercial license terms, and non-DOD Departments and Agencies of the U.S. Government will receive no greater than Restricted Rights as defined in FAR 52.227-19(c)(1-2) (June 1987). U.S. Government users will receive no greater than Limited Rights as defined in FAR 52.227-14 (June 1987) or DFAR 252.227-7015 (b) (2) (November 1995), as applicable in any technical data.

Technology Licenses

The hardware and/or software described in this document are furnished under a license and may be used or copied only in accordance with the terms of such license.

Contacting Keysight

Assistance with test and measurements needs and information on finding a local Keysight office are available on the Web at: <http://www.keysight.com/find/assist>

If you do not have access to the Internet, please contact your Keysight field engineer.

In any correspondence or telephone conversation, refer to the Keysight product by its model number and full serial number. With this information, the Keysight representative can determine whether your product is still within its warranty period.

Safety and Regulatory Information

The safety and regulatory information pertaining to this product is located on page 146.

Where to Find the Latest Information

Documentation is updated periodically. For the latest information, please visit: <http://www.keysight.com/find/fieldfox>

Software Updates

Is your product software up-to-date? Periodically, Keysight releases software updates to fix known defects and incorporate product enhancements. To search for software updates for your product, go to www.keysight.com/find/fieldfoxsupport

Elements of this product's Software use SharpZipLib as an "as provided" stand alone capability.

Copyright 2004 John Reilly

This program is free software; you can redistribute it and/or modify it under the terms of the GNU General Public License as published by the Free Software Foundation; either version 2 of the License, or (at your option) any later version.

This program is distributed in the hope that it will be useful, but WITHOUT ANY WARRANTY; without even the implied warranty of MERCHANTABILITY or FITNESS FOR A PARTICULAR PURPOSE. See the GNU General Public License for more details.

To receive a copy of the GNU General Public License, write to the Free Software Foundation, Inc., 59 Temple Place - Suite 330, Boston, MA 02111-1307, USA.

Linking this library statically or dynamically with other modules is making a combined work based on this library. Thus, the terms and conditions of the GNU General Public License cover the whole combination.

As a special exception, the copyright holders of this library give you permission to link this library with independent modules to produce an executable, regardless of the license terms of these independent modules, and to copy and distribute the resulting executable under terms of your choice, provided that you also meet, for each linked independent module, the terms and conditions of the license of that module. An independent module is a module which is not derived from or based on this library. If you modify this library, you may extend this exception to your version of the library, but you are not obligated to do so. If you do not wish to do so, delete this exception statement from your version.

Elements of this product's software use ANTLR.

Copyright (c) 2005-2008 Terence Parr

All rights reserved.

Conversion to C#: Copyright (c) 2008-2009 Sam Harwell, Pixel Mine, Inc.

All rights reserved.

Redistribution and use in source and binary forms, with or without modification, are permitted provided that the following conditions are met:

1. Redistributions of source code must retain the above copyright notice, this list of conditions and the following disclaimer.
2. Redistributions in binary form must reproduce the above copyright notice, this list of conditions and the following disclaimer in the documentation and/or other materials provided with the distribution.
3. The name of the author may not be used to endorse or promote products derived from this software without specific prior written permission.

THIS SOFTWARE IS PROVIDED BY THE AUTHOR "AS IS" AND ANY EXPRESS OR IMPLIED WARRANTIES, INCLUDING, BUT NOT LIMITED TO, THE IMPLIED WARRANTIES OF MERCHANTABILITY AND FITNESS FOR A PARTICULAR PURPOSE ARE DISCLAIMED.

IN NO EVENT SHALL THE AUTHOR BE LIABLE FOR ANY DIRECT, INDIRECT, INCIDENTAL, SPECIAL, EXEMPLARY, OR CONSEQUENTIAL DAMAGES (INCLUDING, BUT NOT LIMITED TO, PROCUREMENT OF SUBSTITUTE GOODS OR SERVICES; LOSS OF USE, DATA, OR PROFITS; OR BUSINESS INTERRUPTION) HOWEVER CAUSED AND ON ANY THEORY OF LIABILITY, WHETHER IN CONTRACT, STRICT LIABILITY, OR TORT (INCLUDING NEGLIGENCE OR OTHERWISE) ARISING IN ANY WAY OUT OF THE USE OF THIS SOFTWARE, EVEN IF ADVISED OF THE POSSIBILITY OF SUCH DAMAGE.

A.07.75 Firmware Release Updates.....	7
Overview.....	8
Options and Features.....	8
Accessories.....	9
FieldFox Manuals, Software, and Supplemental Help.....	9
Preparing for Initial Use of Your New FieldFox.....	11
Check the Shipment.....	11
Meeting Power Requirements for the AC/DC Adapter.....	11
Install the Lithium-Ion Battery.....	12
FieldFox ON/OFF Settings.....	13
FieldFox High-Temperature Protection.....	14
Avoid Overpowering the FieldFox.....	14
Take the FieldFox Tour.....	15
How to Enter Numeric Values.....	19
NA (Network Analyzer) Mode.....	20
NA Mode Settings.....	21
Time Domain - Option 010.....	36
Time Domain (Transform) Settings.....	37
Trace Settings.....	40
Gating.....	41
CAT (Cable and Antenna Test) Mode - Option 305.....	44
CAT Mode Settings.....	45
Return Loss Measurements.....	51
1-Port Cable Loss Measurements.....	51
2-Port Insertion Loss Measurements.....	52
DTF (Distance to Fault) Measurements.....	54
DTF Measurement Settings.....	55
Calibration for NA, CAT, and VVM Modes.....	62
Verifying Calibration and Jumper Cable Integrity.....	76
Calibration Method Summary.....	77

Power Meter Mode	78
Power Meter Settings.....	79
Frequency Offset using Power Sensor (FOPS) – Option 208....	85
FOPS Settings	86
Pulse Measurements Mode - Option 330.....	91
Pulse Measurement Settings.....	92
VVM (Vector Voltmeter) Mode	102
Overview	103
VVM Mode Settings.....	103
1-Port Cable Trimming Measurements.....	107
2-Port Transmission Measurements.....	108
A/B and B/A Measurements	108
Data Analysis Features	110
All about Markers.....	110
All about Limit Lines	118
All about Trace Math.....	122
File Management.....	124
Saving and Recalling Files	124
Printing.....	130
System Settings	131
Run/Hold	131
Preset	132
User Preset.....	132
Volume Control	133
Display Settings.....	133
Preferences.....	135
System Configuration	138
Service Diagnostics.....	144
Working with the Lithium-Ion Battery.....	146
Viewing Battery Charge Status.....	146
Charging the Battery.....	147

Reconditioning the Battery 149

Battery Care..... 150

Maximizing Battery Life..... 150

Lithium Ion Battery Disposal 151

Safety Considerations 152

 Certification and Compliance Statements..... 159

Appendix A: Connector Care Review..... 161

Appendix B: Specifications/Data Sheet 162

Appendix C: Instrument Calibration 163

Index..... 164

A.07.75 Firmware Release Updates

For customers upgrading FieldFox firmware, the following is a list of changes from the previous release:

NA Mode

Big Marker Display States 33

VVM Mode

VVM 180° Short Phase Offset..... 106

All Modes (System)

Update/Set Time using Internet..... 142

Overview

Options and Features

The FieldFox may be ordered to include the following options and features:

Options and Features	Learn more
RF Vector NA Mode <ul style="list-style-type: none">2 MHz to 4 GHz (Option 104)2 MHz to 6 GHz (Option 106)Forward Measurements S11, S21Full 2-port S-parameters (Option 122) Adds S22, S12 and Full 2-port Calibration.	NA Mode on page 20 Cal on page 62.
Cable and Antenna Test (CAT) Mode (Option 305) <ul style="list-style-type: none">2 MHz to 4 GHz (Option 104)2 MHz to 6 GHz (Option 106) Measurements: <ul style="list-style-type: none">Distance-to-fault (DTF)DTF & Return LossReturn Loss (dB)VSWRDTF (VSWR)Cable Loss (1-Port)Insertion loss (2-Port)	CAT Mode on page 44
QuickCal (Option 112) Built-in cal kit. Industry first!	Cal on page 64
Power Meter Mode (Option 302) Use with Keysight External USB Power Sensors	Power Meter Mode on page 78
Vector Voltmeter (VVM) Mode (Option 308) Measure electrical length	VVM Mode on page 102
Measurements: <ul style="list-style-type: none">1-Port Cable Trimming (Mag and Phase)2-Port Transmission (Mag and Phase)	
Designed for Field Environment <ul style="list-style-type: none">Lightweight 6.2 lbs (2.8 kg) including batteryRugged, weather resistant shell with no fan/ventsDaylight viewable 6.5" (16.5 cm) color LCDBacklit keys for night useIntegrated kickstandConfigurable hand and shoulder strapsSoftcase for carrying all gearQuick Reference Guide with laminated pages	
Slots for removable USB Flash Drive and micro SD Card <ul style="list-style-type: none">Expands internal storageUseful for file transfer	Save / Recall on page 126

- Flash Drive and micro SD Card not included
- FieldFox release 4.0 supports micro SDHC (high-capacity) Card

Battery or AC Power

On page 146.

- Rechargeable Li-Ion battery with ~4 hr life
- Easily removable battery
- AC/DC adapter
- External battery charger (N9910X-872)

FieldFox Data Link Software

- **Basic capability to print measurement traces on a PC.**
- Capability to create/modify cal kit and cable definition files.
- Help file included with the software installation
- Download the latest version of the software at www.keysight.com/find/fieldfoxsupport

Additional Features

Languages on page 135

- Menus localized to 7 languages
-

Accessories

The following accessories are included with every N9923A FieldFox. Spare accessories can be ordered at any time.

Accessory Part Number	Description
8121-1351	Cable-Assembly Patch-5E RJ-45 Male/RJ-45 Male 7 FT-LG
N9910X-873	AC/DC Adapter
N9910X-870	Lithium-Ion Battery
N9910X-880	Softcase w/ Backpack & Shoulder Strap
N9910X-884	Instrument Shoulder Strap
N9910X-890	User's Guide (printed copy)
N9910X-891	Quick Reference Guide (printed copy)

NOTE Although not supplied, a USB keyboard CAN be used with the FieldFox.

To see a complete list of accessories that are available for the FieldFox, please visit: <http://www.keysight.com/find/fieldfox>.

FieldFox Manuals, Software, and Supplemental Help

The following manuals and software are available for the FieldFox. For the very latest versions, please visit the FieldFox support website at:

www.keysight.com/find/fieldfoxsupport

Check the manual revision on the first page of each manual.

- **User's Guide** – This manual, included with shipment.
- **Quick Reference Guide** – Printed copy with laminated pages for outdoor use included with shipment.
- **Supplemental Online Help** – Concepts and Reference information
<http://na.support.keysight.com/fieldfox/help/FieldFox.htm>

- **FieldFox Data Link Software and Help** – Free download.
- **Service Guide** – Free download .
- **Firmware Updates** – Check to see if you have the latest FieldFox firmware.

Conventions that are used in the Manual

- **Hardkey** indicates a front panel button. The functionality of these buttons does not change.

The six Softkey menus change dynamically and follow these color conventions:

- **Softkey** Blue indicates an available setting.
- **Softkey** Green indicates a change in menu level when selected.
- **Softkey** Black indicates the default or selected setting.
- **Softkey** Yellow indicates an active entry in process.
- **Softkey** Grey indicates a key that is NOT available.

Safety Notes

The following safety notes are used throughout this manual. Familiarize yourself with each of the notes and its meaning before operating this instrument. More pertinent safety notes for using this product are located in “Safety Considerations” on page 146.

CAUTION

Caution denotes a hazard. It calls attention to a procedure that, if not correctly performed or adhered to, could result in **damage to or destruction of the product**. Do not proceed beyond a caution notice until the indicated conditions are fully understood and met.

WARNING

Warning denotes a hazard. It calls attention to a procedure which, if not correctly performed or adhered to, could result in **injury or loss of life**. Do not proceed beyond a warning note until the indicated conditions are fully understood and met.

Preparing for Initial Use of Your New FieldFox

Check the Shipment

When you receive your FieldFox, check the shipment according to the following procedure:

1. Inspect the shipping container for damage. Signs of damage may include a dented or torn shipping container or cushioning material that indicates signs of unusual stress or compacting. If not damaged, **save the packaging material** in case the FieldFox needs to be returned.
2. Carefully remove the contents from the shipping container, and verify that the standard accessories and your ordered options are included in the shipment according to the Box Contents List.
3. For any question or problems, refer to Contacting Keysight on page 2.

Meeting Power Requirements for the AC/DC Adapter

Voltage: 100 VAC to 250 VAC

Frequency: 50 Hz to 60 Hz

Current: 1.25 – 0.56 A

The AC/DC adapter supplied with the analyzer is equipped with a three-wire power cord, in accordance with international safety standards. The power cable appropriate to the original product shipping location is included with the FieldFox.

Various AC power cables are available from Keysight that are unique to specific geographic areas. You can order additional AC power cables that are correct for use in different areas. For the power cord part number information please visit:

<http://www.keysight.com/find/fieldfox>

Install the Lithium-Ion Battery



Step	Notes
1. Open the battery door.	Push the button on the battery compartment door while sliding the door outward.
2. Insert the battery.	The terminals end of the battery is inserted into the compartment.
3. Close the battery door.	Slide the battery compartment door upwards until it latches.

Battery Usage

When you receive your FieldFox, the lithium-ion battery is not installed, and it is partially charged to approximately 40% to preserve battery life. A lithium-ion battery has no memory effect, so it can be used partially charged, as shipped.

A fully charged battery will power your FieldFox for about four hours, so if you plan to use it for this long, you should fully charge the battery.

NOTE The FieldFox will shut down to prevent the battery from discharging to a level that is damaging. If this occurs, charge the battery either internally or externally.

Learn more about the lithium-ion battery on page 146.

Battery charge status is viewable:

-  In the upper-right corner of the screen.
- On the Battery screen. To access the screen, select **System**, **Service**, **Diagnostics**, and **Battery**.
- On the battery. Open the FieldFox battery compartment door to view the battery LCD.

To conserve battery power:

- Use **Run/Hold** to single-trigger a measurement when needed. **Hold** is shown on the display.
- Press **System** then **Display** then **Brightness**. Use the **▲▼** arrows, the rotary knob, or numeric keypad to adjust the brightness to dim the FieldFox display as much as possible.
- Briefly press the power button to switch to Stand By mode when the FieldFox is not being used. Press again to restore power. All current settings are preserved.

NOTE

When powered by the battery only, the FieldFox can stay in Stand By mode for a maximum of four hours and then it powers off automatically. When the relative battery charge drops about 20%, the FieldFox will power off to preserve the remaining charge.

To recharge a battery:

Use ONLY a FieldFox charger to recharge a battery.

- The battery can be fully charged while in the FieldFox in about 4 hours with the FieldFox either ON or OFF.
- It can be fully charged externally using the external battery charger (Opt 872) in about 4 hours.

When the battery is removed, the FieldFox can still be powered by the AC/DC adapter.

FieldFox ON/OFF Settings

- To turn power **ON**, briefly press the power button. The LED is green. Boot-up takes about 1 minute.
- To switch to **Stand By** mode (low battery drain), briefly press the power button. To turn power ON, briefly press the power button. Power and settings are restored instantly. See the Note above concerning Stand By mode.
- To turn Power **OFF** (very low battery drain), press and hold the power button until power is OFF - about 4 seconds. Data and instrument state are NOT automatically saved when the FieldFox is powered OFF. Learn how to save data and instrument state on page 124.
- You can make a setting to automatically **Power ON** the FieldFox when a power source is connected. Learn how on page 144.

Power button LED status

- Solid green – Power is ON
- Blinking green – FieldFox in Stand By mode
- Blinking amber – Battery charging.
- Blinking amber and green – Stand By mode and battery charging.
- Not lit – Power is Off and battery is not charging.

FieldFox High-Temperature Protection

The following features prevent degradation or damage in the event of high internal temperatures in the FieldFox.

NOTE Do NOT store the FieldFox in the softcase while powered ON or in Stand By mode.

How to monitor the internal FieldFox temperature:

- Press **System**, then **Service Diagnostics**.
- Then **Internal Temperatures**.
- The temperature at which the following events occur is the average of the RF1, SB1, SB2 temperatures. These temperatures come from internal sensors embedded within FieldFox.

Temperature Control Mode

At approximately 73 °C, the FieldFox enters Temperature Control mode by reducing display intensity and measurement speed. This should decrease the internal temperature which preserves measurement accuracy and maintains the long-term reliability of the FieldFox.

When entering Temperature Control mode, save your instrument state and data that you want to keep.

When the temperature drops to approximately 71°C, normal operating settings are restored.

NOTE Measurement speed specifications do NOT apply in Temperature Control Mode.

High-Temp Shutdown

In extreme situations, Temperature Control mode may not stop an increase in the FieldFox internal temperature. At approximately 75°C, High-Temperature Shutdown will engage and turn OFF the FieldFox.

Just prior to shutdown, the FieldFox will display a warning of imminent shut down.

Avoid Overpowering the FieldFox

The FieldFox can be damaged with too much power or voltage applied. Exceeding the maximum RF power levels shown below will cause an **ADC Over Range** message to appear on the screen.

WARNING

Maximum Input Voltages and Power:

- Port 1 and Port 2 Connector: ±50 VDC, +23 dBm RF
- External Trig/Ref Connector: 5.5 VDC
- DC Input: 19 VDC,

NOTE Very often, coaxial cables and antennas build up a static charge, which, if allowed to discharge by connecting to the FieldFox, may damage the instrument input circuitry. To avoid such damage, it is recommended to dissipate any static charges by temporarily attaching a short to the cable or antenna prior to attaching to the FieldFox.

Take the FieldFox Tour

Front Panel

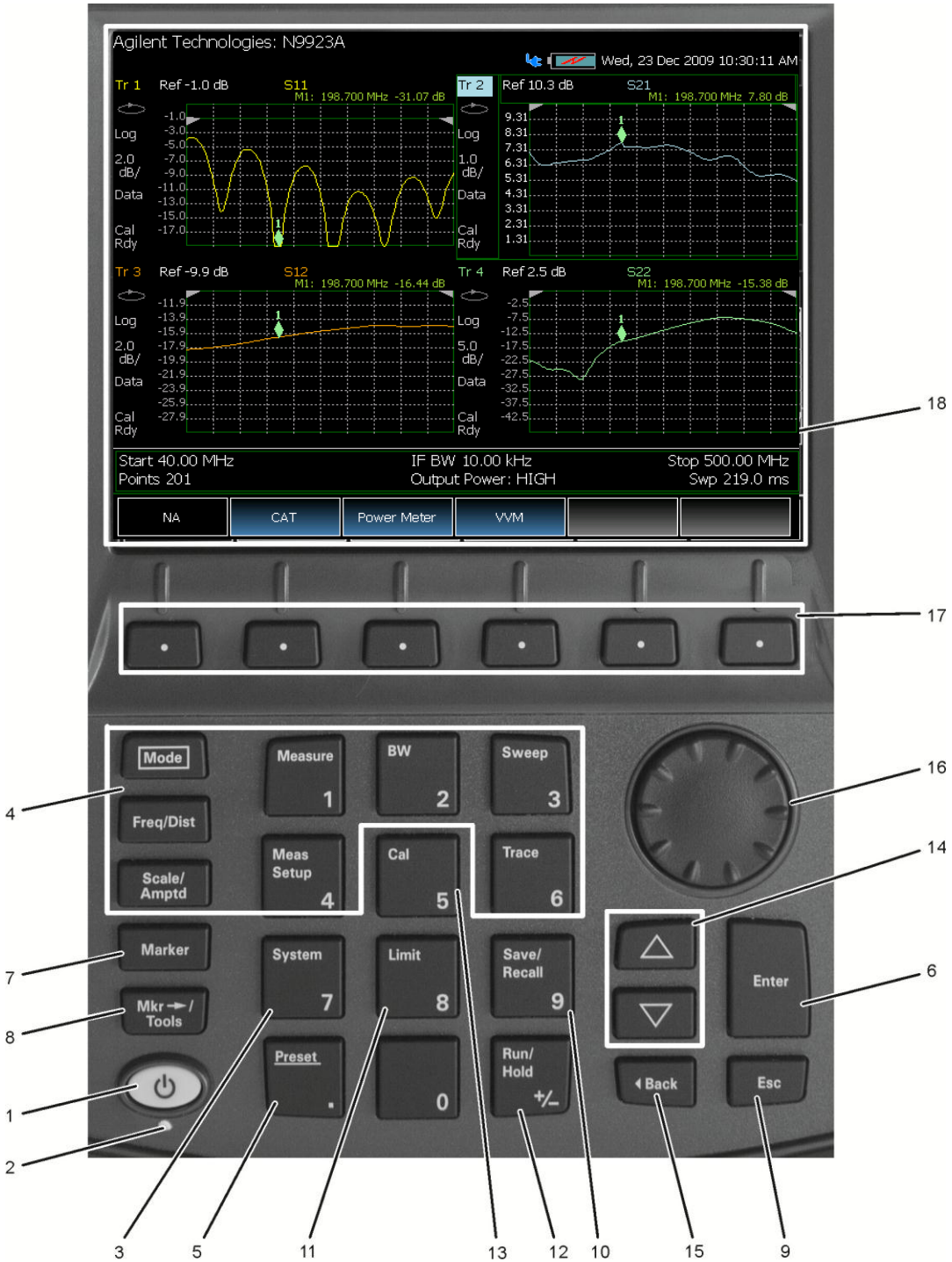

N9912_001_401

Front Panel

No.	Caption	Description	Learn More on Page:
1	Power	ON: press momentarily. STAND BY: with FieldFox power ON, press briefly. OFF: press and hold about 4 seconds until the FieldFox shuts off.	13
2	LED	Not lit: FieldFox OFF, not charging Green: FieldFox ON. Charging status indicated by battery icon on screen Orange, flashing: FieldFox STAND BY Orange, intensity increasing, flashing slowly: FieldFox OFF, charging	13
3	System	Displays a submenu for system setup	130
4	Function keys	Includes: Freq/Dist , Scale/Amptd , BW , Sweep , Trace , Meas Setup , Measure , and Mode	Refer to specific Mode.
5	Preset	Returns the analyzer to a known state	132
6	Enter	Confirms a parameter selection or configuration	--
7	Marker	Activates marker function	110
8	Mkr→/Tools	Displays a submenu for marker functions	113
9	Esc	Exits and closes the dialog box or clears the character input	--
10	Save/Recall	Saves the current trace or recalls saved data from memory	124
11	Limit	Sets limit lines for quick Pass/Fail judgment	118
12	Run/Hold	Toggles between free Run and Hold/Single operation.	131
13	Cal	Displays a submenu for calibration functions	62
14	Arrow keys	Increases or decreases a value or setting.	--
15	◀Back	Returns to the previous menu selection.	--
16	Rotary knob	Highlights an item for selection, or enables incremental changes to values.	--
17	Softkeys	Allows selection of settings for configuring and performing measurements, and for other FieldFox functions.	--
18	Screen	Transflective screen, viewable under all lighting conditions. If you are using your FieldFox in direct sunlight, you do not need to shield the display from the sunlight. In bright lighting conditions, the display is brighter and easier to read when you allow light to fall directly on the screen. Alternative color modes exist that maximize viewing in direct sunlight conditions, as well as other conditions such as nighttime work. Note: Clean the Transflective screen with gentle and minimal wiping using Isopropyl alcohol applied to a lint-free cloth.	132 - Display settings 18 - Screen Tour







Top Panel



Caption	Description	Learn More
Port 1	For CAT and NA measurements, contains source and A / R1 receivers. Maximum: ± 50 VDC, +23 dBm RF	CAT Mode on page 44 NA Mode on page 20
Ext Trig/Ext Ref	External Reference BNC connector to connect to an external frequency reference. Maximum: 5.5 VDC. External Triggering is not used on the N9923A.	Ext Ref on page 139
Port 2	For CAT and NA mode, contains source and B / R2 receivers. Maximum: ± 50 VDC, +23 dBm RF.	CAT Mode on page 44 NA Mode on page 20

Side Panel



Caption	Description	Learn More
	Ethernet cable connector to read trace data using the FieldFox Data Link Software.	Data Link webpage
	Reserved for future use.	
	DC power connector used to connect to the AC/DC adapter. Maximum: 19 VDC, 4 ADC.	On page 12
	Micro Secure Digital slot. Use to extend the memory of the FieldFox.	File locations on page 124
	Standard USB connector used to connect a power sensor for Power Meter Mode. Also used to save files to a USB flash drive. Use of Keyboard and Mouse is NOT supported.	File locations on page 124
	Audio output jack.	

Screen Tour

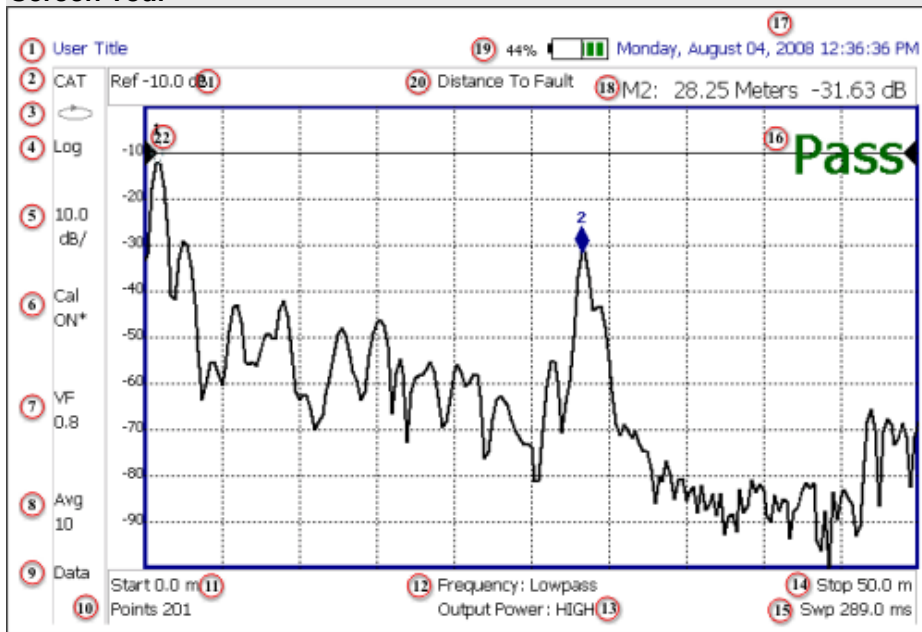

Caption	Description	Learn More on Page:
1	Title – write your own text here	134
2	Current Mode	
3	Run / Hold	131
4	Display Format	26
5	Scale/division	Mode dependent
6	Calibration Status (CAT and NA)	62
7	Velocity Factor (Fault Meas)	57
8	Averaging Status and Count	Mode dependent
9	Data / Mem Display (CAT and NA)	122- Trace Math
10	Resolution Setting	Mode dependent
11	Measurement Start Freq or Distance	Mode dependent
12	Bandpass / Lowpass setting (Fault Meas) IF BW in NA Mode	57
13	Output Power Level (CAT and NA)	49
14	Measurement Stop Freq or Distance	Mode dependent
15	Actual Sweep Time	Mode dependent
16	Limit Line Status	118
17	Time and Date	142
18	Marker Readout	110
19	Battery Status	146
20	Measurement Type (CAT and NA)	
21	Reference Level	Mode dependent
22	Reference Position	Mode dependent

How to Enter Numeric Values

Many settings on the FieldFox require the entry of numeric values.

How to enter numeric values

Use any combination of the following keys:

- Numeric 0–9 keys, along with the polarity (**+/-**) key.
- Up/Down arrow keys to increment or decrement values.
- Rotary knob to scroll through a set of values.
- **Back** erases previously entered values.
- **Esc** exits data entry without accepting the new value.

To complete the setting:

- Press **Enter** or a different **softkey** or **hardkey**.

Multiplier Abbreviations

Many times after entering numeric values, a set of multiplier or suffix softkeys are presented. The following explains the meaning of these abbreviations.

Select Frequency multipliers as follows:

- **GHz** Gigahertz (1e9 Hertz)
- **MHz** Megahertz (1e6 Hertz)
- **kHz** Kilohertz (1e3 Hertz)
- **Hz** Hertz

Select Time multipliers as follows:

- **s** Seconds
- **ms** milliseconds (1e-3)
- **us** microseconds (1e-6)
- **ns** nanoseconds (1e-9)
- **ps** picoseconds (1e-12)

NA (Network Analyzer) Mode

Learn more about NA Mode measurements in the FieldFox Supplemental Online Help: <http://na.support.keysight.com/fieldfox/help/FieldFox.htm>

In this Chapter

How to Measure S-parameters	21
Mixed-mode measurements.....	22
Parameter Conversion	22
Receiver Measurements	22
Multi-Trace Configurations	23
Quick Settings.....	25
Calibration Settings	26
Format.....	26
Frequency Range.....	27
Scale Settings.....	27
Electrical Delay	28
Phase Offset	28
Averaging.....	29
IF Bandwidth.....	29
Smoothing.....	30
Single/Continuous.....	30
Resolution (number of points).....	30
Sweep Time.....	31
Output Power.....	31
System Impedance	32
Port Extensions	32
Velocity Factor	33
Increase Dynamic Range.....	33

See Also

All about Calibration.....	62
Set Markers.....	110
Use Limit Lines.....	118
Use Trace Math.....	122

Making 75Ω (ohm) Measurements at the FieldFox Supplemental Online Help:
<http://na.support.keysight.com/fieldfox/help/FieldFox.htm>

NA Mode Settings

Select NA Mode before making any setting in this section.

How to select NA Mode

- Press **Mode**.
- Then **NA**.

About S-parameters

S-parameters (scattering parameters) are used to describe the way a device modifies a signal. The FieldFox can measure **four S-parameters**. The syntax for each parameter is described by the following:

S (out | in)

out = FieldFox receiver port

in = FieldFox source port

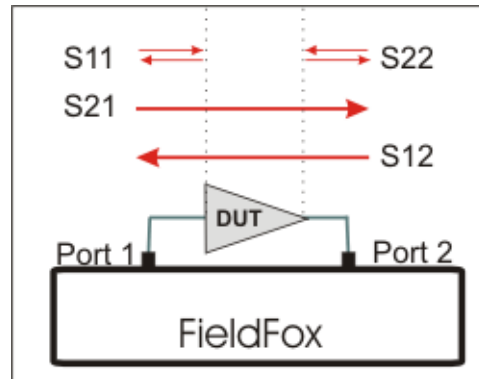

The FieldFox automatically switches the internal source and receivers to make both forward and reverse measurements. Therefore, the FieldFox can measure all four S-parameters with a single connection.

When the source comes from port 1, the measurement is said to be in the **forward** direction.

When the source comes from port 2, the measurement is said to be in the **reverse** direction, which requires Option 122.

S11 and S22 reflection measurements are used to measure the amount of reflections off the corresponding DUT port. Low reflections means there is a good impedance match between the source and DUT.

S21 and S12 transmission measurements are used to measure the loss or gain through a DUT over a specified frequency range. Both ends of the DUT must be connected to the FieldFox. The FieldFox signal source is transmitted out one of the test port connectors, through the DUT, and into the other test port connector.

How to measure S-parameters

1. Press **Preset** then **Preset**
2. Press **Measure 1** then choose from the following:
 - **S11** Reflection measurement at port 1.
 - **S21** Forward 2-port transmission measurement.
 - **S12** Reverse 2-port transmission measurement. Requires Opt 122.
 - **S22** Reflection measurement at port 2. Requires Opt 122.

OR select a multi-trace configuration. Learn more on page 23.

3. Press **Freq/Dist** then either **Start** and **Stop** or **Center** and **Span** to enter a Frequency Range for the measurement.
4. Press **BW 2** then **IFBW** to select the IF Bandwidth for the measurement. Narrower bandwidths require more time to sweep, but lowers trace noise.
5. Press **Sweep 3** then **Resolution** to select the number of data points for the measurement. More data points require more time to sweep.
6. Press **Cal 5** to calibrate the measurement. Learn more on page 62.
7. All other settings, described in the following section, can be made AFTER calibration without compromising measurement accuracy.

Mixed-Mode S-Parameters

In NA Mode ONLY, mixed-mode S-parameters (also known as Balanced measurements) are available with Option 212.

Because the FieldFox has only two test ports, only reflection measurements are available. Connect the balanced input or output of your DUT to the FieldFox ports 1 and 2.

For highest accuracy, a Full 2-port calibration is required.

All FieldFox settings and features are supported (except Parameter Conversion) with mixed-mode S-parameters.

NOTE Learn more about Balanced Measurements with the FieldFox in the FieldFox Supplemental Online Help:
<http://na.support.keysight.com/fieldfox/help/FieldFox.htm>

How to make mixed-mode S-parameter measurements

- Press **Measure 1**
- Then **More**
- Then choose from the following:
 - **Scc11** Common reflect/common incident for logical port 1
 - **Sdd11** Differential reflect/differential incident for logical port 1
 - **Sdc11** Differential reflect/common incident for logical port 1.
 - **Scd11** Common reflect/differential incident for logical port 1.

To make balanced reflection measurements at the DUT output, connect the DUT output to the FieldFox ports.

Parameter Conversion

In NA Mode ONLY, converts the active S-parameter trace to an equivalent impedance (Z), admittance (Y), or reciprocal 1/S-parameter.

How to select parameter conversions

- Press **Measure 1**
- Then select an S-parameter
- Then **More**
- Then **Conversion**
- Then choose from the following:

- **Off** (default) No conversion is performed.
- **Z Conv (--)** or **Y Conv (--)** Perform conversion for impedance (Z) or admittance (Y). Then choose from the following for either:
 - **Auto** The displayed S-parameter is converted to the **appropriate** Z or Y parameter: Refl for S11 and S22; Trans for S21 and S12. When the S-parameter is changed, the appropriate conversion changes automatically.
 - **Refl** The displayed S-parameter is converted to Z or Y **reflection**, regardless of whether the S-parameter is reflection (S11 or S22) or transmission (S21 or S12).
 - **Trans** The displayed S-parameter is converted to Z or Y **transmission**, regardless of whether the S-parameter is reflection (S11 or S22) or transmission (S21 or S12).
- **1/S** The displayed S-parameter is converted to 1/S-parameter.

Receiver Measurements

In NA Mode ONLY, you can make unratioed, uncorrected receiver measurements. These measurements are typically used as diagnostic tools for service personnel.

NOTE The receivers measurements are NOT corrected for absolute power. They are only useful for making relative measurements. The Y-Axis and markers are labeled in dB - NOT dBm. Specifically, R1 and R2, do NOT indicate the actual power levels out of the source ports. The actual power levels are close to the typical output power of +6 dBm (High power) and -40 dBm (Low power).

How to make receiver measurements

- Press **Measure 1**
- Then **Advanced**
- Then choose from the following:

A Port-1 test port (*1)	B Port-2 test port (*2)
R1 Port-1 reference receiver (*1)	R2 Port-2 reference receiver (*2)

(*) indicates the Auto-selected source port for the measurement

- **Source Port** The FieldFox port to provide the source signal. Choose from the following:
 - **Auto** The FieldFox sets the source port based on the selected receiver.
 - **Port 1** Select when measuring transmission at B receiver.
 - **Port 2** Select when measuring reverse transmission at A receiver.

Learn more about Raw Receiver Measurements at the FieldFox Supplemental Online Help: <http://na.support.keysight.com/fieldfox/help/FieldFox.htm>

Multi-Trace Configurations

In NA Mode you can display multiple traces on the FieldFox screen.

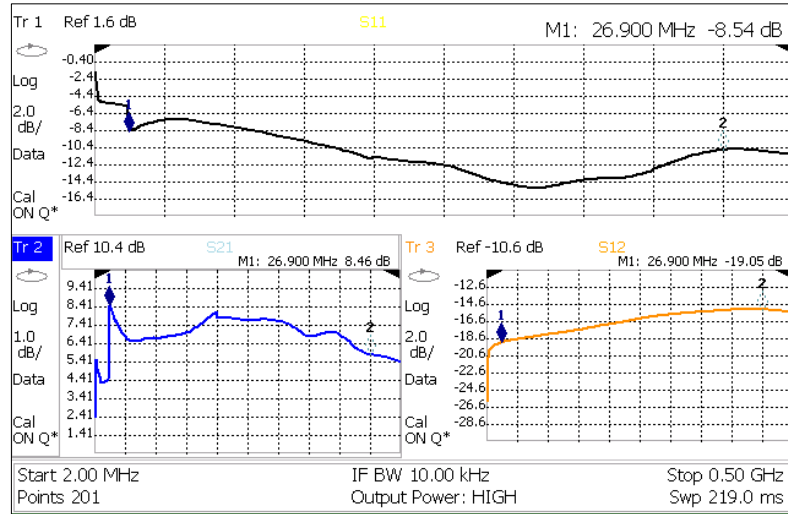

A 3-trace configuration. Tr2 is the ACTIVE trace as indicated by the highlighted Tr 2

Trace Setting Notes

- The Frequency Range, IF BW, Resolution, Average, and Output Power settings are common for all displayed traces.
- All other trace settings, such as measurement, format, and limit lines, are applied individually to the **ACTIVE** trace in the same manner as when a single trace is present.
- By default, a marker is created on ALL traces as shown in the above image. However, they can be created individually by disabling Coupled Markers. Learn more on page 112.

How to select a multi-trace configuration

- Press Trace 6
- Then Num Traces
- Then choose from the following:
Default measurements depend on the options that are installed.
 - x1 1 trace standard configuration
 - x2 2 traces **overlayed** on a single graticule
 - x2H 2 traces on separate **horizontal** graticules
 - x3H 3 traces on separate **horizontal** graticules
 - X3 3 traces **overlayed** on a single graticule
 - x4 4 traces on separate graticules
- How to activate a trace in order to change a setting
- Use the ▲▼ arrows **OR**
- Press Trace 6 then select Trace 1, Trace 2, Trace 3, or Trace 4. Only traces that are shown can be activated.

How to maximize the viewing of the active trace

- Press **System 7**
- Then **Full Screen**
- Press any key to return to the standard display.

Quick Settings

Both NA and CAT Modes allow you to view and change most relevant settings from a single location.

Setting	Value
Common Settings	
Start	2.000000 MHz
Stop	6.000000000 GHz
Center Frequency	3.001000000 GHz
Span	5.998000000 GHz
Resolution	201
Output Power	High
Average	4
Interference Rei.	Off
Number of Traces	x1
System zo	50
Trace 1 Settings	
Measurement	S11
Format	Log Mag
Trace 2 Settings	
Measurement	S21
Format	Log Mag

The Quick Settings menu. The resolution is being edited.

NOTE Interference Rejection and System Z0 can be changed ONLY from the Quick Settings menu. Learn more about these settings on pages 31 and 32. ALL other settings can also be made using the standard softkey menus.

How to view and change Quick Settings

- Press **Meas Setup 4**.
- Then **Settings**.
- Press **Next Page** and **Previous Page** to view all settings. If these softkeys are NOT available, then all available settings fit on one page.
- To change a setting:
 - Use the **▲▼** arrows to highlight a setting.
 - Then press **Edit**. The current setting changes to **yellow**.
 - Some settings require you to press a softkey to change the value. Otherwise, use the numeric keypad, **▲▼** arrows, or rotary knob to change the value.
 - When finished changing a value, press **Done Edit**.
- Press **Dock Window** to relocate the Settings table to a position relative to the trace window. The Dock Window setting persists through a Preset. Choose from the following:
 - **Full (Default setting)** Only the Settings table is shown on the screen. The trace window is temporarily not shown.
 - **Left** The Settings table is shown to the left of the trace window.

- **Bottom** The Settings table is shown below the trace window.
- When finished changing ALL settings, press **Done** to save your settings.

Calibration Settings

NA Mode has a page specifically for making settings that pertain to Port Extensions, including Velocity Factor and Media Type.

Learn more about Port Extensions on page 32.

Learn more about Media Type in Waveguide Calibrations on page 73.

How to view and change Calibration Settings

- Press **Meas Setup 4**.
- Then **Calibration Settings**
- Make these settings in the same manner as Quick Settings in the previous section.

Format

Select the display format in which to present measurement results. This setting can be changed at any time without affecting calibration accuracy.

NOTE Learn more about **Display Format** at the FieldFox Supplemental Online Help: <http://na.support.keysight.com/fieldfox/help/FieldFox.htm>

The marker onscreen readout can be changed to formats other than the display format. Learn how to set marker format on page 114.

How to select a NA Format

- Press **Measure 1**.
- Then **Format [current setting]**.
- Then choose from the following:
 - **Log Magnitude** Displays magnitude in dB
 - **Linear** Displays positive values only. Y-axis: Unitless (U) for ratioed measurements; Watts (W) for unratioed measurements.
 - **VSWR** Used mainly for S11 and S22. Displays unitless reflection data.
 - **Phase** Displays phase in degrees. The trace 'wraps' every 360 degrees, from +180 to -180, for easy scaling.
 - **Smith** Used mainly for S11 and S22. Displays series resistance and reactance.
 - **More** then...
 - **Polar** Used mainly for S11 and S22. Displays magnitude and phase of the reflection coefficient.
 - **Group Delay** Used mainly for S21 and S12. Displays signal transmission (propagation) time through a device in seconds. The Group Delay aperture is the current Smoothing aperture. Default is 1.5 % of the X-axis.
 - Learn how to set Smoothing aperture on page 30.
 - Learn more about Group Delay measurements at the FieldFox Supplemental Online Help: <http://na.support.keysight.com/fieldfox/help/FieldFox.htm>
 - **Unwrap Phase** Same as Phase, but without 180 degree wrapping.

NOTE Phase is unwrapped by comparing the phase from one data point to the next. If the phase difference between two data points is greater than 180 degrees, or if the phase of the first data point is greater than 180 degrees from DC, then the phase measurement is probably NOT accurate. To ensure that the phase measurement is accurate, increase the resolution setting. When making a narrowband measurement, reduce the start frequency for the unwrapped phase measurement to ensure the first data point is less than 180 degrees from DC.

Frequency Range

Set the range of frequencies over which you would like to make measurements. When the frequency range is changed after a calibration is performed, the cal becomes interpolated. Learn more on page 62.

How to set Frequency Range

This can be done in two ways:

- Press **Freq/Dist**
- Then choose from the following:
 1. **Start** and **Stop** frequencies – Specify the beginning and end of the sweep.
 2. **Center** and **Span** frequencies – Specify the center frequency and span of frequencies (half on either side of center).
- Follow each by entering a value using the numeric keypad, the **▲▼** arrows, or the rotary knob.
- After using the **▲▼** arrows or the rotary knob, press **Enter**. The increment setting of the arrows is based on the current span and can NOT be changed in NA Mode.
- After using the keypad, select a multiplier key. Learn about multiplier abbreviations on page 19.

Scale Settings

Adjust the Y-axis scale to see the relevant portions of the data trace. The Y-axis is divided into 10 graticules.

This setting can be changed at any time without affecting calibration accuracy.

How to set Scale

- Press **Scale / Amptd**.
- Then choose from the following methods:
 1. **Autoscale** Adjusts the Y-axis to comfortably fit the Min and Max amplitude of the active trace.
 2. **Autoscale All** Autoscales all of the traces on the screen. Useful for multi-trace configurations.
 3. **Set Scale, Reference Level, and Reference Position**
 - **Scale** Manually enter a **scale per division** to view specific areas of the trace.
 - **Ref Level** Manually set the value of the reference line. Enter a negative value by pressing **Run/Hold (+/-)** either before or after typing a value.
 - **Ref Position** Manually set the position of the reference line. Values must be between 0 (TOP line) and 10 (BOTTOM line)

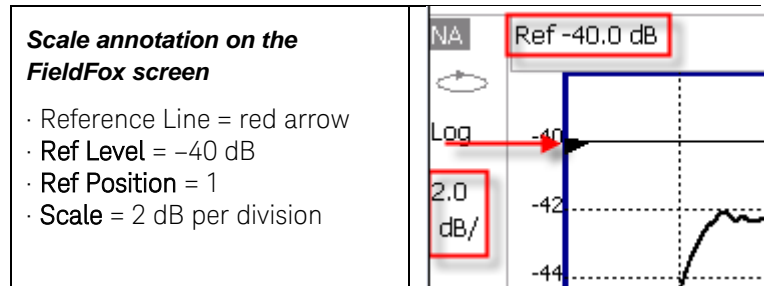

Electrical Delay

Electrical delay is a mathematical function that simulates a variable length of lossless transmission line. Use the electrical delay feature to compensate for the linear phase shift through a device and view only the deviation from linear phase of the device.

You can set the electrical delay independently for each measurement trace. To apply an electrical delay to all measurement traces, use Port Extensions. Learn how on page 32.

How to set Electrical Delay

- Press **Scale / Amptd**
- Then **More**
- Then **Electrical Delay**
- Enter a time value using the numeric keypad, the **▲▼** arrows, or the rotary knob.
- Press a multiplier key. Learn about multiplier abbreviations on page 19.

Phase Offset

Phase offset mathematically adjusts the phase measurement by a specified amount, up to 360°. Use this feature in the following ways:

Improve the display of a phase measurement. This is similar to the way you would change the reference level in an amplitude measurement. Change the phase response to center or align the response on the screen.

Emulate a projected phase shift in your measurement. For example, if you know that you need to add a cable and that the length of that cable will add a certain phase shift to your measurement, you can use phase offset to add that amount and simulate the complete device measurement.

You can set the phase offset independently for each measurement trace.

How to set Phase Offset

- Press **Scale / Amptd**
- Then **More**
- Then **Phase Offset**
- Enter a value in degrees using the numeric keypad, the **▲▼** arrows, or the rotary knob. Press **Enter**

Averaging

Averaging helps to reduce the effects of random noise on a measurement. You specify the number of measurements to be averaged. The more measurements averaged, the greater the amount of noise reduction. An average counter is shown in the left edge of the screen as **Avg <n>** where <n> is the number of measurements that are averaged.

Averaging can be set before or after calibration. When set before calibration, each calibration standard is measured <n> times and averaged. More time is needed to perform the calibration, but there will be less noise in the resulting error terms which means that subsequent measurements will also have less noise. In addition, noise is further reduced by continuing to average after calibration.

How to set Averaging

- Press **BW 2**.
- Then **Average <n>** where <n> is the number of measurements to average.
- Enter a value using the numeric keypad. Enter 1 for NO averaging.
- Press **Enter**.
- Then **Average Mode** Choose from the following:
 - **Sweep** - Each data point is based on the average of the same data point being measured over <n> consecutive sweeps. The average counter shows the number of previous sweeps that have been averaged together to form the current trace. When the counter reaches the specified count, then a 'running average' of the last <n> sweeps is displayed.
 - **Point** - Each data point is measured <n> times and averaged before going to the next data point. On subsequent sweeps, averaging restarts by measuring each data point again <n> times. The average counter is not updated because data is not displayed until all the averages have been applied.
 - **Point averaging is usually faster than sweep averaging.** However, you may need to increase the Point Average count to obtain the same level of noise reduction as with sweep averaging.
- While averaging is in process, press **Sweep 3** then **Restart** to restart the averaging at 1.

IF Bandwidth

The FieldFox converts the received signal from its source to a lower intermediate frequency (IF). The bandwidth of the IF bandpass filter is adjustable. Reducing the IF receiver bandwidth reduces the effect of random noise on a measurement. However, narrower IF bandwidths cause longer sweep times.

How to set IF BW

- Press **BW 2**.
- Then **IF BW**
- Then choose from the following: **300 Hz | 1 kHz | 3 kHz | 10 kHz | 30 kHz**

Smoothing

Trace smoothing averages a number of **adjacent** data points to smooth the peak-to-peak noise values on a displayed trace. The number of adjacent data points that are averaged is known as the smoothing aperture. Aperture is set by specifying a percentage of the X-axis span.

Trace smoothing does NOT significantly increase measurement time.

Smoothing is used in Group Delay measurements, although it can be used with any NA format EXCEPT Polar or Smith Chart. Learn more about NA Mode formats, including Group Delay, on page 26.

When enabled, **Smo** appears on the FieldFox screen.

How to set Smoothing

- Press **BW 2**.
- Then **Smoothing ON OFF**.
- Then **Sm. Aperture** and enter a value between 0 and 25 (percent) using the numeric keypad.
- Press **Enter**.

Single or Continuous Measure

This setting determines whether the FieldFox measures continuously or only once each time the **Single** button is pressed. Use **Single** to conserve battery power or to allow you to save or analyze a specific measurement.

This setting can be changed at any time without affecting calibration accuracy.

How to set Single or Continuous

- Press **Sweep 3**.
- Then choose one of the following:
 - **Single** Automatically sets Continuous OFF and causes FieldFox to make ONE measurement, then hold for the next Single key press. When a data trace is displayed, the entire trace is measured, then holds. The **Hold** annotation changes to an arrow **-->** while the measurement occurs.
 - **Continuous ON OFF** Makes continuous measurements. This is the typical setting when battery power is not critical.

You can also use **Run / Hold +/-** to toggle between Single and Continuous.

Resolution (Number of Data Points)

Data points are individual measurements that are made and plotted across the X-axis to form a trace. Select more data points to increase measurement resolution. However, more data points requires more time to complete an entire measurement sweep.

When the Resolution is changed after a calibration is performed, the cal becomes interpolated. Learn more on page 62.

How to set Resolution

- Press **Sweep 3**.
- Then **Resolution**.

- Then choose from the following:
101 | 201 | 401 | 601 | 801 | 1001 | 1601 | 4001 | 10001.
- Using SCPI, Resolution can be set to any number of points between 3 and 10001. See the Programming Guide at www.keysight.com/find/fieldfoxsupport

Sweep Time

The fastest possible sweep time is always used as the default setting. Use the **Min Swp Time** setting to slow the sweep time when measuring long lengths of cable.

Learn more about measuring long cable lengths at the FieldFox Supplemental Online Help: <http://na.support.keysight.com/fieldfox/help/FieldFox.htm>

The actual sweep time is shown on the FieldFox screen. See the Screen Tour on page 18. To increase the sweep time, enter a value that is higher than the actual sweep time. The increase will not be exactly the amount that you enter, as the actual sweep time is the composite of many factors.

NOTE Measurement speed specifications do NOT apply in Temperature Control Mode. Learn more on page 14.

How to set Sweep Time

- Press **Sweep 3**.
- Then **Min Swp Time**.
- Enter a value using the numeric keypad.
- Press a multiplier key. Learn about multiplier abbreviations on page 19.

Output Power

Set the power level out of the FieldFox to High, Low, or manually set power level to a value between High and Low.

Generally, the high power setting is used when measuring passive, high-loss devices to place the signal farther from the noise floor. However, for devices that are sensitive to high power levels such as amplifiers, use the Low power setting.

For best measurement accuracy, use the **Manual** power setting at -15 dBm. After calibration, the power level can be decreased for amplifiers, or increased for higher dynamic range.

Caution Power Level settings in this mode will NOT change Power Level settings in other modes. To help prevent damage to your DUT, use caution when changing modes with your DUT connected to the FieldFox test ports.

How to set Output Power

Output power is NOT leveled with any of the power settings.

- Press **Meas Setup 4**.
- Then **Power**.
- Then **Output Power**
 - **High** (Default setting) Sets output power to the maximum achievable power at all displayed frequencies. Please see the FieldFox Specifications for expected power levels.
 - **Low** Sets output power to approximately -42 dBm.
 - **Man** Set output power to an arbitrary value.

- Then press **Nominal Power**
- Then enter a value using the numeric keypad, the **▲▼** arrows, or the rotary knob.
- Press **Enter**.

System Impedance (Z0)

To accurately view data presented in Smith Chart format, first set the System Impedance. Learn how to select Smith Chart format on page 26.

Learn how to make 75Ω measurements at the FieldFox Supplemental Online Help: <http://na.support.keysight.com/fieldfox/help/FieldFox.htm>

How to set System Impedance

- Press **Meas Setup 4**.
- Then **Settings**
- Then scroll to **System zo** and press **Edit**.
- Then type either **50** or **75** and press **Enter**.

Port Extensions

Port extensions allow you to electrically move the calibration reference plane on either port 1 or port 2 after you have performed a calibration.

NOTE FieldFox analyzers do NOT support port extensions for waveguide component measurements.

Why use Port Extensions

Use port extensions if you are unable to perform a calibration directly at your device because the location is not accessible. Perform a calibration at a convenient place, then use port extensions to compensate for the time delay (phase shift) to the desired reference plane. On the FieldFox, port extensions does not compensate for the loss of the additional electrical length, nor any mismatch errors beyond the calibration reference plane.

Also use port extensions if you have already performed a calibration, and then decide that you need to add a length of transmission line in the measurement configuration. Use port extensions to "tell" the FieldFox that you have added the length to a specific port..

- With S11 and S22 reflection measurements, the FieldFox doubles the port extension valued that you enter to account for the additional delay in the forward and reverse directions.
- With S21 and S12 transmission measurements, the port 1 and port 2 extensions are added together. This accounts for the total transmission delay going through ports 1 and 2.

Port extensions and Electrical Delay differ in the following ways:

- Electrical delay applies to a specific trace
- Port extensions apply to specific hardware ports

Port Extensions and Electrical Delay can be set independently. When both are set, the delay adds together. Learn more about Electrical Delay on page 28.

How to apply Port Extensions

- Press **Meas Setup 4**.
- Then **Port Extensions**
- Then **Port Extensions ON**
- Then **Port1 Extension** or **Port2 Extension**
- Then enter time value using the numeric keypad, the **▲▼** arrows, or the rotary knob. Press **Enter** or select a seconds (time) multiplier.

You can also set Port Extensions by pressing **Meas Setup 4** then **Calibration** (settings).

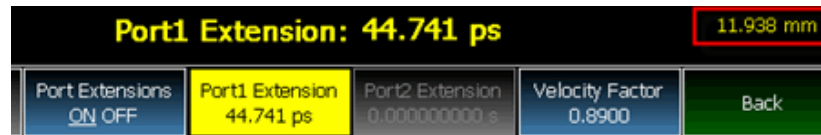

While setting Port Extension, the physical length of the extension (in meters ONLY), at the current Velocity Factor setting, is visible to the right (red box in above image).

Velocity Factor

The electrical delay or port extension value is entered as delay, or **electrical length**, in units of time.

Entering the velocity factor causes the FieldFox to accurately display the equivalent **physical length** in meters (NOT available in feet) that corresponds to the entered electrical delay.

Velocity factor is the ratio of the velocity of wave propagation in a coaxial cable to the velocity of wave propagation in free space. This velocity depends on the relative permittivity of the cable dielectric (ϵ_r).

$$\text{Velocity factor} = 1/\sqrt{\epsilon_r}$$

VF = 0.66 corresponds to wave propagation through a polyethylene dielectric.

VF = 1.0 (default setting) corresponds to wave propagation through free space (a vacuum).

How to set Velocity Factor

- Press **Meas Setup 4**.
- Then **Port Extensions**
- Then **Velocity Factor**
- Then enter a value between 0.1 and 1 using the numeric keypad, then press **Enter**.

You can also set Velocity Factor by pressing **Meas Setup 4** then **Calibration** (settings).

Big Marker Display States (A and B)

This feature, available ONLY in NA Mode, allows you to view up to three Big or Super Big marker readouts. This is done by using up to two different display states called A and B. Each display state is comprised of the settings listed below. When the Big Readout setting is toggled through A and B, these display states are recalled.

How to create Big Marker Display States

To have big readouts, markers MUST be created using the following procedure. If you have already set up your display and do not want to lose it, then save the current state to a state file. Learn how on page 124. The following procedure will overwrite your display state.

- Press **Mkr ->/ Tools**
 - Then **Big Readout**
 - **A or B** - The A or B display state is recalled. If none have been defined, then the default display state is recalled.
 - **OFF** - The B display state is visible but without the Big Marker Readout.
- With A or B selected, then press **Edit Big Marker (A or B)**
- Then edit the following display state settings:
 - **Num Traces** – Choose the Multi-Trace configuration **x1**, **x2**, or **x3**. Only Overlaid configurations are allowed. Learn more on page 23.
 - **Font Size** – Choose either Big or Super Big. Super Big marker readout #3 will cover some of the measurement grid.
 - **Trace Settings** - For each possible trace (1, 2, and 3) select from the following:
 - **Measurement** – S-Parameter or Receiver measurement to display. **S11** is default. Learn more starting on page 21.
 - **Meas Format** – **Log** is default. Learn more on page 26
 - **Bandwidth (ON)** – Marker readout for marker bandwidth search. **OFF** is default. Learn how to set BW parameters on page **Error! Reference source not found.**114.
 - **Big Readout** - For each marker readout (1, 2, and 3), select from the following:
 - **Marker #** - Enter a number from 1 to 6 to create the marker. **1** is created by default.
 - **Trace #** - The marker# is created on this trace. **Tr1** is selected by default. The corresponding Num Traces must first be selected. For example, to create a marker on Trace 3, first select Num Traces = **x3**.
 - **Format** – Format for the marker readout. Select Default to make the marker readout format the same as the display format. **Default** is selected by default.
 - **Mkr Tracking** – **ON**: Select the parameter to track on the standard Marker Search menu. **OFF** is selected by default. When set to **ON**, Peak tracking is set by default. Learn about Marker Tracking on page 114.
 - **State** – Choose from Normal, Delta, or OFF. The default marker (1) is created in Normal. Learn more on page 111.
 - **Enabled** – Turns the Big Readout of the corresponding marker **ON** and **OFF**. The default marker (1) is set **ON** by default.

Notes:

- To move a marker, press **Marker**, then **Marker**, then scroll to the marker number to be moved. The new marker position can NOT be saved with the A or B display state.

- Settings that are NOT listed above are NOT affected by the recalled display states.
- Changes to the above settings outside the Big Readout menu will be overwritten when Big Readout (A or B) is selected. For example, suppose the display format for the B state is Log. If you change the display format to Lin using the standard menu (Meas 1, Format), the setting will show on the display. But if you then use the Big Readout (A | B | OFF) setting, when B is recalled, the Lin setting will be overwritten with the original Log setting.

Increase Dynamic Range

Dynamic range is the difference between maximum input power to the FieldFox receiver (without compressing the receiver), and the minimum measurable power (noise floor). Measurement accuracy is increased when the DUT response is at least 10 dB above the noise floor. For a measurement to be valid, input signals must be within these boundaries.

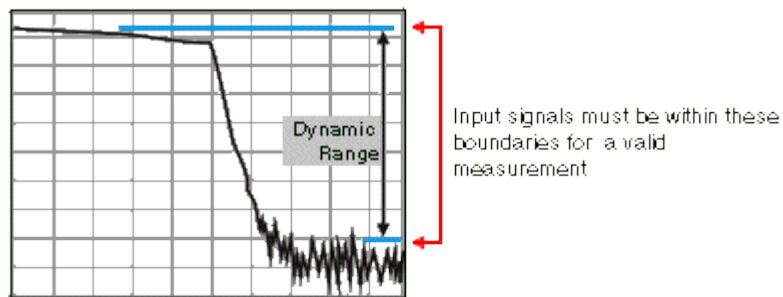

The following settings will increase the dynamic range of your NA mode measurement.

- Increase Power Level: Press **Meas 4** then **Output Power High**
- Lower the IFBW: Press **BW 2** then **IF BW**
- Increase Averaging: Press **BW 2** then **Average**

The following procedure MAY increase the dynamic range of your NA mode measurement. The results you see will depend on the performance of your DUT.

With an S21 trace active:

1. With RF OUT (port-2) open, press **Trace 6** then **Math and Memory** then **Data->Mem**
2. Re-connect the DUT.
3. Press **Data Math** then **Data-Mem**

Time Domain - Option 010

With NA Mode, Time Domain (Opt 010), frequency information is used to calculate and display measurements with time as the horizontal display axis. The response values appear separated in time allowing a different perspective of the test device's performance and limitations.

NA Mode settings that are NOT unique to Time Domain are documented in the NA Mode chapter on page 20

In this Chapter

Overview..... 36

Time Domain (Transform) Settings

Transform Settings Table 37

Frequency Range and Points 38

Stimulus (Mode)..... 38

Set Frequency Lowpass..... 38

Start/Stop Time 38

Distance Units..... 39

Window Layout 39

Transform Window 39

Line Loss and Velocity Factor..... 40

Data Chain 40

Trace Settings

Transform Enable..... 41

Gating Enable 41

Gating Settings

Start, Stop, Center, and Span Gate Times..... 42

Gating Type..... 42

Overview

In normal NA Mode operation, the FieldFox measures the characteristics of a test device as a function of frequency. With Time Domain (opt 010), frequency information is used to calculate the inverse Fourier transform and display measurements with time on the horizontal display axis. The response values appear separated in time, allowing a different perspective of the test device's performance and limitations.

The graphic below compares the same cable reflection measurement data in both the frequency and time domain. The cable has two bends. Each bend creates a mismatch or change in the line impedance.

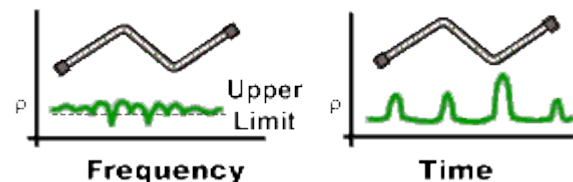

The frequency domain of an S11 measurement shows reflections caused by mismatches in the cable. It is impossible to determine where the mismatches physically occur in the cable.

The Time Domain response shows both the location and the magnitude of each mismatch. The responses indicate that the second cable bend is the location of a significant mismatch. This mismatch can be gated out, allowing you to view the frequency domain response as if the mismatch were not present. Learn more about gating on page 41.

Markers that are created on a Time Domain trace can be used to pinpoint the distance of the mismatch from the reference plane.

For more information on Time Domain theory, see <http://literature.cdn.keysight.com/litweb/pdf/5989-5723EN.pdf>

Time Domain (Transform) Settings

You can set and view most of the Time Domain settings on the Transform Settings table.

Transform Settings Table

The following settings are listed in the order they appear on the Transform Settings menu selection.

How to make settings on the Transform settings table

- Press **Meas Setup 4**.
- Then **Transform**.
- Then **Transform Settings**.
- Press **Next Page** and **Previous Page** to view all settings.
- To change a setting:
 - Use the **▲▼** arrows or rotary knob to highlight a setting.
 - Numeric settings can be changed by pressing numbers using the numeric keypad. Then press **Enter** or select a suffix if available.
 - Some settings allow you to press **Edit** to toggle the value. Other settings require that you then press a softkey to change the value.
 - When finished changing a value, press **Done Edit**.
- Press **Dock Window** to relocate the Settings table to a position relative to the trace window. The Dock Window setting persists through a Preset. Choose from the following:
 - **Full (Default setting)** Only the Settings table is shown on the screen. The trace window is temporarily not shown.
 - **Left** The Settings table is shown to the left of the trace window.
 - **Bottom** The Settings table is shown below the trace window.
- When finished changing ALL settings, press **Done** to save your settings.

Frequency Range and Points

Like CAT mode, all Time Domain measurements are made in the frequency domain and, using Inverse Fourier Transform (IFT), time is calculated. Select the frequency range from which Time Domain measurements are calculated. Increasing the data points will improve measurement resolution. However, more data points will usually result in slower sweep updates.

Set frequency range and points before selecting Stimulus Mode.

Stimulus (Mode)

There are three variations on how the Time Domain transform algorithm is applied to the frequency domain measurement. Each method has a unique application.

- **Lowpass Impulse** - Highest resolution. Most useful for seeing small responses in devices that pass low frequencies, such as cables.
- **Lowpass Step** - Easiest to identify inductive and capacitive discontinuities in devices that pass low frequencies such as cables.

In both Lowpass modes, frequencies down to DC and negative frequencies are extrapolated. Therefore, when either Lowpass mode is selected, **Set Freq.Low Pass** is automatically applied to adjust the start frequency. Learn more about Set Frequency Lowpass below.

When the Start Frequency or resolution is changed AFTER selecting a Lowpass mode, then Stimulus mode is set to **Band Pass** and Transform is disabled.

- **Band pass** - Easiest method - can be used with any frequency sweep. Most useful for measuring band limited devices such as filters and DC blocked cables. This mode does NOT show capacitive and inductive reactance. For the same frequency span and number of points, band pass mode has twice the impulse width, which hides closely spaced responses degrading the response resolution.

Set Frequency Lowpass

NOTE This setting is made automatically when either Lowpass mode is selected.

USE ONLY IN LOW PASS MODES. When this setting is made, the start frequency is adjusted to be harmonics of the start frequency. Start frequency is computed by the following formula:

Low Pass Start Frequency = Stop Frequency / Number of points.

Start/Stop Time

The following settings adjust the **display resolution**, allowing you to zoom IN or OUT on a response. When the start or stop time is updated, they may be automatically adjusted to limit the display to one alias-free response on either side of zero time.

How to set Start and Stop time

- Press **Measure 4**
- Then **Transform**
- Then **Transform Start Stop**
- Then choose from:
 - **Start** Sets the transform start time.
 - **Stop** Sets the transform stop time.

NOTE Zero (0) seconds is always the **calibration reference plane**. Negative values are useful if moving the reference plane.

Distance Units

When markers are present on a Time Domain trace, marker X-axis values are shown both in units of time (seconds) and distance. Select the units in which the marker distance data is presented.

Distance Units are also used when setting Time Domain Line Loss. Learn more on page 40.

Choose from: m (meters), or Feet.

Window Layout

This setting is used to create additional traces, or select a new layout for traces that are already created,

Choose from: x1, x2, x2H, x3H, x4.

Learn more about multi-trace configurations on page 23.

Transform Window

There are abrupt transitions in a frequency domain measurement at the start and stop frequencies, causing overshoot and ringing in a Time Domain response. The Window setting reduces the abruptness of the frequency domain transitions. This causes you to make a tradeoff in the Time Domain response.

The Window setting applies to ALL traces.

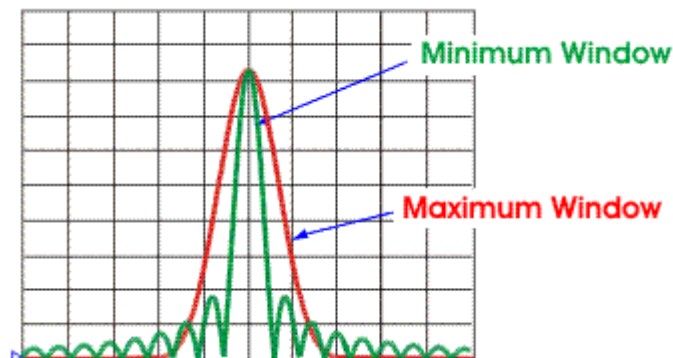

How to make Window setting

- Press **Measure 4**
- Then **Transform**
- Then **More**
- Then **Transform Window**
- A settings table appears that allows you to navigate and select the following settings. These settings are made exactly like those made on the Transform Settings table. Learn how on page 37.

NOTE Any of the following four methods can be used to make this same Window setting. Impulse Width values are calculated from the frequency span and Kaiser Beta value.

1. Window	Min	Medium	Max
2. Percent	0	50	100
3. Kaiser Beta	0	6.50	13.00
4. Impulse Width	100.455 ps	168.501 ps	231.284 ps

Line Loss and Velocity Factor

By default, the FieldFox does NOT correct Time Domain measurements to account for the inherent loss of a cable. However, to make more accurate measurements, Line Loss and Velocity Factor should be considered.

About Velocity Factor and Line Loss

- Velocity Factor is a property of the physical material of a cable. A VF of 1.0 corresponds to the speed of light in a vacuum, or the fastest VF possible. A polyethylene dielectric cable has VF = 0.66 and a cable with PTFE dielectric has VF = 0.7.
- Line Loss is specified in dB/m (or ft). In addition to the length of the cable, loss is also directly proportional to the frequency of the signal that passes through the cable.

The following is an example showing how Line Loss works:

The DUT is a 100 meter transmission cable. The Line Loss value is .1 dB/meter. This means that a signal traveling ONE WAY through the cable will lose 10 dB of power (100 m * .1dB/m). Because the FieldFox performs this measurement with 1 port, the test signal travels down the cable and then back, for a total loss of 20 dB.

For the purpose of illustrating this point, connect an OPEN to the end of the cable – a maximum-sized fault – for 100% reflection of the 300 MHz test signal.

Without compensation for the loss of the cable, a –20 dB response would be visible at 100 meters, which is the OPEN at the end of the DUT. This is from 10 dB of loss through the cable in each direction.

With compensation for the loss using the manufacturer’s specification, the FieldFox compensates the trace as though the signal traveling through 100 meters was increased by +20 dB. Therefore the response will show 0 dB for 100% reflection.

Data Chain

This setting, available only on the Table Settings, reverts to the default when the FieldFox is Preset. Choose from the following:

- Standard** – The normal FieldFox data processing chain. Transform calculations are performed AFTER error correction and trace math.
- 8510** – The data processing chain used by the Keysight 8510 network analyzer. Transform calculations are performed BEFORE error correction and trace math. Learn more at the FieldFox Supplemental Online Help website:
<http://na.support.keysight.com/fieldfox/help/FieldFox.htm>

Trace Settings

The following two settings apply to specific traces.

Transform Enable

Enable Time Domain transform for the specific trace.

- Select the trace.
- Press **Measure 4**
- Then **Transform**
- Then choose from:
 - **On** Trace displays Time Domain data.
 - **Off** Trace displays frequency domain data.

Gate Enable

Enable Gating for the specific trace.

- Select the trace.
- Press **Measure 4**
- Then **Transform**
- Then choose from:
 - **On** Trace displays Time Domain data.
 - **Off** Trace displays frequency domain data.

Gating

Perhaps the most beneficial feature of Time Domain transform is the Gating function. When viewing the Time Domain response of a device, the gating function can be used to "virtually" remove undesired responses. You can then simultaneously view a frequency domain trace as if the undesired response did not exist. This allows you to characterize devices without the effects of external devices such as connectors or adapters.

Gating is best performed while viewing a Time Domain trace. Then, either disable Transform, or separately view a frequency domain trace to see the trace with the gated effects removed.

NOTE When a discontinuity in a test device reflects energy, that energy will not reach subsequent discontinuities. This can "**MASK**", or hide, the true response which would have occurred if the previous discontinuity were not present. The Gating feature does NOT compensate for this.

The following image shows how gating can affect measurement results.

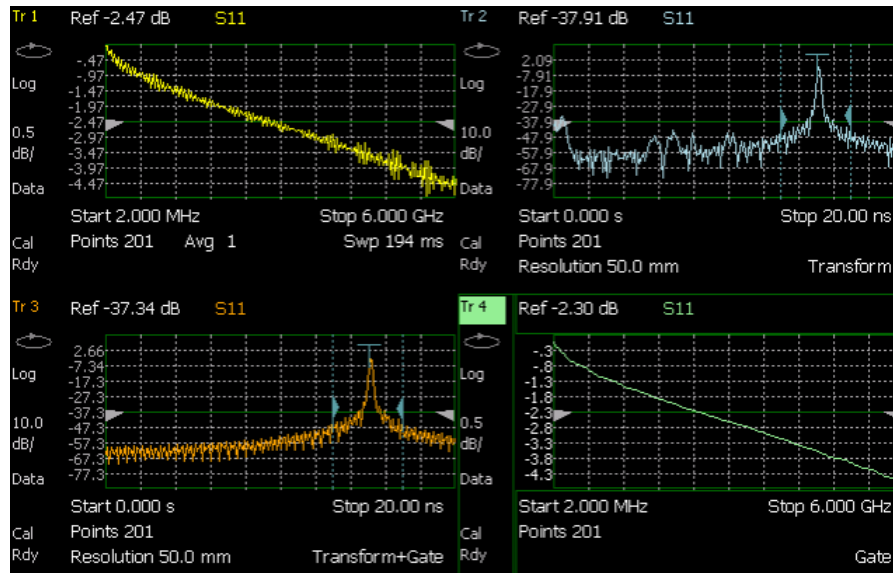

All 4 traces show the same S11 measurement.

Trace 1 shows the frequency response **without** gating enabled.

Trace 2 shows the transform response **without** gating enabled.

Trace 3 shows the transform response **with** gating enabled.

Trace 4 shows the frequency response **with** gating enabled.

How to make Time Domain Gating settings

- Press **Measure 4**
- Then **Transform**
- Then **Gating**
- Then choose from:
 - **On** Gating is being performed.
 - **Off** Gating is NOT being performed.

Start, Stop, Center, and Span Gate Times

These settings specify the time in the trace to be gated (in or out). The gate times can be specified using either Start and Stop or Center and Span.

- Press **Gating Start/Stop**
- A settings table appears that allows you to navigate and select the following settings. These settings are made exactly like those made on the Transform Settings table. Learn how on page 37.

Gating Type

This setting defines the type of filtering that will be performed for the gating function. The gate start and stop flags on the display point toward the part of the trace you want to keep.

- Choose from the following:
 - **Bandpass** - KEEPS the responses within the Gating Start and Stop times.

- **Notch** - REMOVES the responses within the Gating Start and Stop times.

Gating Shape

This setting defines the filter characteristics of the gate function. Choose from Minimum, Normal, Wide, Maximum.

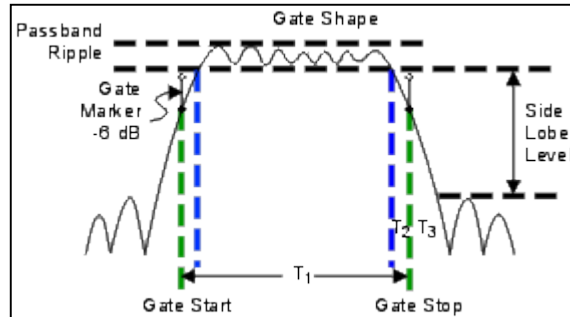

Time domain Gate Shape setting

Gate Shape	Passband Ripple	Sidelobe Levels	Cutoff Time	Minimum Gate Span
Minimum	±0.1 dB	-48 dB	1.4/Freq Span	2.8/Freq Span
Normal	±0.1 dB	-68 dB	2.8/Freq Span	5.6/Freq Span
Wide	±0.1 dB	-57 dB	4.4/Freq Span	8.8/Freq Span
Maximum	±0.01 dB	-70 dB	12.7/Freq Span	25.4/Freq Span

Cutoff time is the time between the stop time (-6 dB on the filter skirt) and the peak of the first sidelobe.

- T_1 is the gate span, which is equal to the stop time minus the start time.
- T_2 is the time between the edge of the passband and the 6 dB point, representing the cutoff rate of the filter.
- T_3 is the time between the 6 dB point and the edge of the gate stopband.

For all filter shapes T_2 is equal to T_3 , and the filter is the same on both sides of the center time.

Minimum gate span is twice the cutoff time. Each gate shape has a minimum recommended gate span for proper operation. This is a consequence of the finite cutoff rate of the gate. If you specify a gate span that is smaller than the minimum span, the response will show the following effects:

- distorted gate shape that has no passband
- distorted shape
- incorrect indications of start and stop times
- may have increased sidelobe levels.

CAT (Cable and Antenna Test) Mode - Option 305

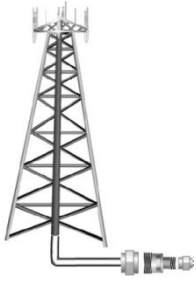

CAT Mode is typically used to test an entire transmission system, from the transmitter to the antenna. This process is sometimes referred to as Line Sweeping.

CAT Mode is similar to NA (Network Analyzer) Mode. Learn more at the FieldFox Supplemental Online Help:

<http://na.support.keysight.com/fieldfox/help/FieldFox.htm>

CAT Mode **Distance to Fault** measurements are discussed on page 54.

In this Chapter

Measurement Selection	45
Quick Settings	46
Frequency Range	46
Scale Settings	47
Averaging	47
Single/Continuous	48
Resolution	48
Sweep Time	49
Output Power	49
Interference Rejection	49
Coupled Frequency	50

Procedures

Return Loss Measurement	51
1-Port Cable Loss Measurement	51
2-Port Insertion Loss Measurement	52
Distance to Fault Measurements	54

See Also

All about Calibration	62
Set Markers	110
Use Limit Lines	118
Use Trace Math	122

CAT Mode Settings

Select **CAT Mode** before making any setting in this chapter.

How to select CAT Mode

- Press **Mode**.
- Then **CAT**.

Measurement Selection

How to select a CAT Mode Measurement

Learn more about the following measurements

- Press **Measure 1**.
- Then choose one of the following: These softkeys also appear after CAT Mode is selected.
 - **Distance to Fault** 1-port reflection measurement that uses Inverse Fourier Transform (IFT) calculations to determine and display the distance to, and relative size of, a fault or disruption in the transmission line. Units are in return loss format, expressed as a positive number in dB, unless the measurement selected is DTF (VSWR). Learn more about DTF Measurements on page 54.
 - **Return Loss & DTF** Displays both a Return Loss measurement and a DTF measurement. Use this format to display the frequency settings that are used to make the DTF measurement. The frequency range settings for these two measurements can be coupled or uncoupled. Learn more on page 50.
 - Calibrations are applied to both traces.
 - When in Hold mode and Single sweep is performed, only the active trace is triggered. Use the **▲▼** arrows to activate a trace.
 - **Return Loss** 1-port reflection measurement that displays the amount of incident signal energy MINUS the amount of energy that is reflected. The higher the trace is on the screen, the more energy being reflected back to the FieldFox. Learn how to measure Return Loss on page 49.
 - **VSWR** (Voltage Standing Wave Ratio – also known as SWR) 1-port reflection measurement that displays the ratio of the maximum reflected voltage over the minimum reflected voltage. The higher the trace is on the screen, the more energy being reflected back to the FieldFox. Learn more about VSWR at the FieldFox Supplemental Online Help:
<http://na.support.keysight.com/fieldfox/help/FieldFox.htm>
 - **DTF (VSWR)** Distance to Fault in VSWR format.
 - **More** Shows the following menu items:
 - **Cable Loss(1-Port)** 1-port reflection measurement that displays the loss of a transmission line. Learn more on page 49.
 - **Insertion Loss (2-Port)** 2-port transmission measurement that accurately displays the loss through a cable or other device in dB. Both ends of the cable must be connected to the FieldFox. NO phase information is included in this measurement. Learn more on page 52.
 - **DTF (Lin)** Distance to Fault in Linear format.

Quick Settings Table

Both CAT and NA Modes allow you to view and change most relevant settings from a single location. All of these settings are discussed in this chapter and, unless otherwise noted, ALL of these settings can also be made using the standard softkey menus.

How to view and change Quick Settings

- Press **Meas Setup 4**.
- Then **Settings**.
- Press **Next Page** and **Previous Page** to view all settings. If these softkeys are NOT available, then all available settings fit on one page.
- To change a setting:
 - Use the **▲▼** arrows to highlight a setting.
 - Then press **Edit**. The current setting changes to **yellow**.
 - Some settings require you to press a softkey to change the value. Otherwise, use the numeric keypad, **▲▼** arrows, or rotary knob to change the value.
 - When finished changing a value, press **Done Edit**.
- Press **Dock Window** to relocate the Settings table to a position relative to the trace window. The Dock Window setting persists through a Preset. Choose from the following:
 - **Full (Default setting)** Only the Settings table is shown on the screen. The trace window is temporarily not shown.
 - **Left** The Settings table is shown to the left of the trace window.
 - **Bottom** The Settings table is shown below the trace window.
- When finished changing ALL settings, press **Done** to save your settings.

Frequency Range

Set the range of frequencies over which you would like to make CAT Mode measurements.

When the frequency range is changed after a calibration is performed, the cal becomes interpolated. Learn more on page 62.

How to set Frequency Range

- Press **Freq/Dist**.
- Then choose from the following:
 - **Start** and **Stop** frequencies – beginning and end of the sweep.
 - **Center** and **Freq Span** frequencies – the center frequency and span of frequencies (half on either side of center).
- Follow each setting by entering a value using the numeric keypad, **▲▼** arrows, or the rotary knob.
 - After using the keypad, select a multiplier key. Learn about multiplier abbreviations on page 19.

- o After using the **▲▼** arrows or the rotary knob, press **Enter**. The amount of frequency increment is based on the current span and can NOT be changed in CAT Mode.

Scale Settings

Adjust the Y-axis scale to see the relevant portions of the data trace. The Y-axis is divided into 10 graticules.

This setting can be changed at any time without affecting calibration accuracy.

How to set Scale

- Press **Scale / Amptd**.
- Then choose from the following:
 1. **Autoscale** Automatically adjusts the Y-axis to comfortably fit the Min and Max amplitude of the trace on the screen.
 2. **Autoscale All** Autoscales all of the traces on the screen, useful only for dual-trace configurations.
 3. Set Scale, Reference Level, and Reference Position
 - o **Scale** Manually enter a **scale per division** to view specific areas of the trace.
 - o **Ref Level** Manually set the value of the reference line. Enter a negative value by pressing **Run/Hold (+/-)** either before or after typing a value.
 - o **Ref Position** Manually set the position of the reference line. Values must be between **0** (TOP line) and **10** (BOTTOM line)
 4. Set Top and Bottom graticule values. The scale per division is calculated
 - o **Top** to set the value of the Top graticule.
 - o **Bottom** to set the value of the Bottom graticule.
 - o Enter a negative value by pressing **Run/Hold (+/-)** either before or after typing a value.

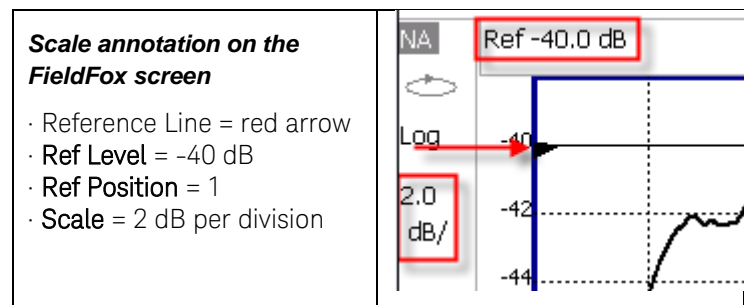

Averaging

Trace Averaging helps to smooth a trace to reduce the effects of random noise on a measurement. The FieldFox computes each data point based on the average of the same data point over several consecutive sweeps.

Average Count determines the number of sweeps to average. The higher the average count, the greater the amount of noise reduction.

An average counter is shown in the left edge of the screen as **Avg N**. This shows the number of previous sweeps that have been averaged together to form the current trace. When the counter reaches the specified count, then a 'running average' of the last **N** sweeps is displayed. Average Count = 1 means there is NO averaging.

This setting can be changed at any time without affecting calibration accuracy.

NOTE Averaging is often used to increase the dynamic range of a measurement. To achieve the highest dynamic range, select NA mode and reduce the IF Bandwidth setting. Learn more about dynamic range on page 33.

How to set Trace Averaging

- Press **BW 2**.
- Then **Average N** where **N** is the current count setting.
- Enter a value using the numeric keypad. Enter 1 for NO averaging.
- Press **Enter**.
- While Trace Averaging is in process, press **Sweep 3** then **Restart** to restart the averaging at 1.

Single or Continuous Measure

This setting determines whether the FieldFox measures continuously or only once each time the **Single** button is pressed. Use **Single** to conserve battery power or to allow you to save or analyze a specific measurement.

This setting can be changed at any time without affecting calibration accuracy.

How to set Single or Continuous

- Press **Sweep 3**.
- Then choose one of the following:
 - **Single** Automatically sets Continuous OFF and causes FieldFox to make ONE measurement, then hold for the next Single key press. When a data trace is displayed, the entire trace is measured, then holds. The **Hold** annotation changes to an arrow --> while the measurement occurs.
 - **Continuous ON OFF** Makes continuous measurements. This is the typical setting when battery power is not critical.
- You can also use **Run / Hold +/-** to toggle between Single and Continuous.

Resolution (Number of Data Points)

Data points are individual measurements that are made and plotted across the X-axis to form a trace. Select more data points to increase measurement resolution. However, more data points require more time to complete an entire measurement sweep.

When the Resolution is changed after a calibration is performed, the cal becomes interpolated. Learn more on page 62.

How to set Resolution

- Press **Sweep 3**.
- Then **Resolution**.
- Then choose one of the following: **101 | 201 | 401 | 601 | 801 | 1001**.

- Using SCPI, Resolution can be set to any number of points between 3 and 10001. See the Programming Guide at www.keysight.com/find/fieldfoxsupport

Sweep Time

The fastest possible sweep time is always used as the default setting. Use the **Min Swp Time** setting to slow the sweep time when measuring long lengths of cable. Learn more about measuring long cable lengths at the FieldFox Supplemental Online Help: <http://na.support.keysight.com/fieldfox/help/FieldFox.htm>

The actual sweep time is shown on the FieldFox screen. See the Screen Tour on page 18. To increase the sweep time, enter a value that is higher than the actual sweep time. The increase will not be exactly the amount that you enter, as the actual sweep time is the composite of many factors.

NOTE Measurement speed specifications do NOT apply in Temperature Control Mode. Learn more on page 14.

How to set Sweep Time

- Press **Sweep 3**.
- Then **Min Swp Time**.
- Enter a value using the numeric keypad.
- Press a multiplier key. Learn about multiplier abbreviations on page 19.

Output Power

Set the power level out of the FieldFox to High, Low, or manually set power level to a value between High and Low.

Generally, the high power setting is used when measuring passive, high-loss devices to place the signal farther from the noise floor. However, for devices that are sensitive to high power levels such as amplifiers, use the Low power setting.

For best measurement accuracy, use the **Manual** power setting at -15 dBm. After calibration, the power level can be decreased for amplifiers, or increased for higher dynamic range.

Caution Power Level settings in this mode will NOT change Power Level settings in other modes. To help prevent damage to your DUT, use caution when changing modes with your DUT connected to the FieldFox test ports.

How to set Output Power

Output power is NOT leveled with any of the power settings.

- Press **Meas Setup 4**.
- Then **Power**
- Then **Output Power**
 - **High** (Default setting) Sets output power to the maximum achievable power at all displayed frequencies. Please see the FieldFox Specifications for expected power levels.
 - **Low** Sets output power to approximately -42 dBm.
 - **Man** Set output power to an arbitrary value.
 - Then press **Nominal Power**

- o Then enter a value using the numeric keypad, the **▲▼** arrows, or the rotary knob.
- o Press **Enter**.

Coupled Frequency

This setting, especially useful for a Return Loss & DTF measurement, allows both measurements to have different frequency ranges.

How to set Coupled Frequency

With a **Return Loss & DTF** measurement present:

- Press **Meas Setup 4**
- Select the DTF measurement (Tr2) using the **▲▼** arrows.
- Then choose from the following:
 - **Coupled Freq ON** - Both the Return Loss and DTF traces have the same frequency range settings.
 - **Coupled Freq OFF** (default setting) - Both traces are allowed to have individual frequency range settings. When set to OFF:
 - o The Return Loss measurement frequency settings are made in the usual manner. Learn how on page 46. When a new Start or Stop frequency is selected, Coupled Frequency is automatically set to OFF.
 - o The DTF measurement is made using the frequencies as determined by the **DTF Frequency Mode** setting. Learn more on page 56.

Interference Rejection

Use this setting when you suspect that other signals in the area are interfering with a measurement. Interference may look like a spike or lack of stability in the measurement trace. While monitoring a measurement at a specific frequency, toggle this setting between ON and OFF. If the measurement result decreases while ON, then there is an interfering signal in the area. Continue to make measurements with Interference Rejection ON. However, this will slow the measurement speed.

Once enabled, up to SIX sweeps may be required before the interfering signal is neutralized.

This setting can be changed at any time without affecting calibration accuracy.

How to set Interference Rejection

- Press **Meas Setup 4**.
- Then **Interference Rejection [current setting]**.
- Then choose from the following:
 - o **Off** No interference rejection and fastest possible sweep speed.
 - o **Minimum** The lowest level of Interference rejection.
 - o **Medium** The medium level of Interference rejection.
 - o **Maximum** The highest level of Interference rejection.

Return Loss Measurements

Return loss can be thought of as the absolute value of the reflected power as compared to the incident power.

When measuring an OPEN or SHORT, all incident power is reflected and approximately 0 dB return loss is displayed.

When measuring a LOAD, very little power is reflected and values of 40 dB to 60 dB are displayed.

The minus sign is usually ignored when conveying return loss. For example, a component is said to have 18 dB return loss, rather than -18 dB.

How to measure Return Loss

- Connect the cable or any adapter used to connect the device under test (DUT).
- Select **Preset** then **Preset**. Returns the FieldFox to known settings.
- Select **Mode** then **CAT** (Cable and Antenna Test)
- Then **Return Loss** (Default measurement).
- Press **Freq/Dist** and enter **Start** and **Stop** frequency values of the measurement.
- Press **Meas Setup 4** then **Settings** to make appropriate settings before calibrating.
- Disconnect the cable or DUT and press **Cal 5** then follow the calibration prompts.
- Reconnect the cable or DUT.
- The return loss trace is displayed on the FieldFox screen.

1-Port Cable Loss Measurements

While all cables have inherent loss, weather and time will deteriorate cables and cause even more energy to be absorbed by the cable. This makes less power available to be transmitted.

A deteriorated cable is not usually apparent in a Distance to Fault measurement, where more obvious and dramatic problems are identified. A Cable Loss measurement is necessary to measure the accumulated losses throughout the length of the cable.

A 2-port Insertion Loss measurement is usually more accurate than a 1-port Cable Loss measurement. However, to perform a 2-port Insertion Loss measurement, both ends of the cable must be connected to the FieldFox.

NOTE In high-loss conditions, a Cable Loss measurement becomes 'noisy' as the test signal becomes indistinguishable in the FieldFox noise floor. This can occur when measuring a very long cable and using relatively high measurement frequencies. To help with this condition, use High Power (page 49) and Averaging. (page 47).

How to make a 1-port Cable Loss Measurement

1. Press **Preset** then **Preset**.
2. Then **More** then **Cable Loss (1-Port)**.
3. Connect the cable to be tested.
4. Press **Freq/Dist** and enter **Start** and **Stop** frequency values of the measurement.

5. Press **Sweep 3** then **Min Swp Time**. Increase the Sweep Time until a stable trace is visible on the screen. The amount of time that is required increases with longer cable lengths. Learn more about measuring long cable lengths at the FieldFox Supplemental Online Help:
<http://na.support.keysight.com/fieldfox/help/FieldFox.htm>
6. Remove the cable to be tested.
7. Press **Cal 5**, then **QuickCal** or **Mechanical Cal**.
8. Follow the prompts to perform calibration at the end of the jumper cable or adapter. Learn more about Calibration on page 64.
9. Connect the cable to be tested.

NOTE Low-level standing waves (also known as 'ripple') which may be visible in reflection measurements, can hide the actual loss of the cable. Steps 10 through 13 can minimize the ripple. Perform the measurement with and without steps 10 through 13 and choose the method with the least amount of ripple.

10. Connect a LOAD at the end of the cable to be tested. This limits the reflections to faults that are located in the cable under test.
11. Press **Trace 6** then **Data->Mem** to store the trace into Memory.
12. Remove the LOAD and leave the end of the cable to be tested open.
13. Press **Data Math** then **Data - Mem**. The ripple in the measurement is removed. These minor imperfections in the cable should not be considered in the Cable Loss measurement.
14. Use Averaging to remove random noise from high-loss measurements. Press **BW 2** then **Average**.

The displayed trace shows the Cable Loss values in one direction through the cable. A Return Loss measurement would show the loss for both down the cable and back. Therefore, a Cable Loss measurement is the same as a Return Loss measurement divided by 2.

The average Cable Loss across the specified frequency range is shown on the screen below the graticules.

2-Port Insertion Loss Measurements

A 2-port Insertion Loss measurement is used to measure the loss through a DUT (device under test) – or cable – over a specified frequency range. The FieldFox signal source is transmitted out the PORT 1 connector, through the DUT, and into the PORT 2 connector. Both ends of the DUT must be connected to the FieldFox., either directly or indirectly using a jumper cable or adapter.

'Insertion' loss simply means **loss** through a device, usually expressed in dB. It is exactly the same measurement as "S21 Transmission" in NA Mode.

2-port Insertion Loss measurements are generally more accurate than 1-port Cable Loss measurements.

How to make a 2-port Insertion Loss Measurement

1. Press **Mode** then **CAT**.
2. Then **More** then **Insertion Loss (2-Port)**.
3. Press **Freq/Dist** and enter **Start** and **Stop** frequency values of the measurement.
4. Press **Sweep 3**, then select a **Resolution** setting.
5. Press **Cal 5**, then perform a calibration. Learn more on page 68.

6. Connect the DUT and view the insertion loss measurement results.

When measuring very long lengths of cable, it may be necessary to increase the sweep time. Learn more about measuring long cable lengths at the FieldFox Supplemental Online Help:

<http://na.support.keysight.com/fieldfox/help/FieldFox.htm>

DTF (Distance to Fault) Measurements

CAT Mode **Distance to Fault** (DTF) measurements are generally used to locate problems, or faults, in a length of cable or transmission line. In this chapter, the cable to be tested is referred to as the DUT (Device Under Test).

Settings that are NOT unique to DTF measurements are documented in the CAT Mode chapter on page 20.

In this Chapter

How to make DTF Measurements	54
DTF Settings Table	55
DTF Measurement (Format)	55
DTF Start and Stop Distance.....	55
Frequency Mode	56
Coupled Frequency.....	57
Cable (Correction) Specifications.....	57
Window Settings.....	60
DTF Units	60
Calculated DTF Values	60
About Alias Faults	61

Optional settings

Markers	110
Limit Lines.....	118
Save Measurement Settings and Results	124

Trace Math is NOT available in DTF Measurements.

How to make DTF Measurements

Before starting, you may need the following:

- Jumper cable or adapter to connect the beginning of the DUT to the FieldFox.
 - LOAD with correct connector type and gender to terminate the end of the DUT (if possible).
 - The known length and cable type of the DUT. If the cable type is not known, then the Cable Loss (dB/Meter) and Velocity Factor of the DUT are required.
1. Connect any necessary jumper cable or adapter to the FieldFox **PORT 1**. Do NOT connect the DUT.
 2. Press **Preset** then **Preset** to return the FieldFox to the default settings.
 3. Then **Mode** then **CAT**.
 4. Then **Distance To Fault**.
 5. Press **Freq/Dist**, then **Stop Distance** and enter the length of the DUT. You can optionally set the **Start Distance**.
 6. Press **Cal 5** and follow the Cal prompts. Learn all about Calibration on page 62.

7. Disconnect any components or antenna that should NOT be measured and connect a LOAD at the end of the DUT.
8. Press **Meas Setup 4** then **DTF Cable Specifications**.
9. Either press **Recall Coax Cable**, or enter the **Velocity Factor** and **Cable Loss** of the DUT.
10. Connect the start end of the DUT to the FieldFox.
11. Press **Meas Setup 4** then **Settings** then **Next Page**. If the **Alias-free Range** setting is **False**, then you may see Alias faults on the screen. Learn more on page 61.

DTF Measurement Settings

DTF Settings Table

You can set and view all of the DTF settings, including some calculated values, on the DTF Settings table. Learn about the calculated values on page 60.

How to make settings on the DTF settings table

- Press **Meas Setup 4**.
- Then **Settings**.
- Press **Next Page** and **Previous Page** to view all settings.
- To change a setting:
 - Use the **▲▼** arrows or rotary knob to highlight a setting.
 - Numeric settings can be changed by pressing numbers using the numeric keypad. Then press Enter or select a suffix if available.
 - Other settings require you to press **Edit**, then press a softkey to change the value.
 - When finished changing a value, press **Done Edit**.
- Press **Dock Window** to relocate the Settings table to a position relative to the trace window. The Dock Window setting persists through a Preset. Choose from the following:
 - **Full (Default setting)** Only the Settings table is shown on the screen. The trace window is temporarily not shown.
 - **Left** The Settings table is shown to the left of the trace window.
 - **Bottom** The Settings table is shown below the trace window.
- When finished changing ALL settings, press **Done** to save your settings.

DTF Measurement (Format)

You can select from 3 different DTF Formats.

- Press **Measure 1**
- Then choose from:
 - **Distance to Fault (dB)** Faults are displayed on the Y-axis in return loss format, expressed as a positive number in dB.

- **DTF (VSWR)** Faults are displayed on the Y-axis in SWR. Learn more about SWR at the FieldFox Supplemental Online Help: <http://na.support.keysight.com/fieldfox/help/FieldFox.htm>
- **More** then **DTF Lin** Faults are displayed on the Y-axis in linear (unitless) format.

DTF Start and Stop Distance

In DTF measurements, you set the physical length of cable or other device to be tested. The FieldFox calculates the frequency range of the measurement from this distance. The longer the cable to be tested, the lower the frequencies that are used. You can also set the frequencies manually using the Frequency Mode [Bandpass] setting.

How to set Start and Stop Distance

- With a DTF measurement present, press **Freq/Dist**.
- Then choose from the following:
 - **Start Distance** Enter a value using the numeric keypad, the **▲|▼** arrows, or the rotary knob, then **Enter**. By default, the Start Distance is set to **0** Meters. This means that the measurement will display faults starting at the point at which calibration standards are connected.
 - **Stop Distance** Enter a value between the start distance and **5 km** (or 16,404 ft.) using the numeric keypad, the **▲|▼** arrows, or the rotary knob, then **Enter**.

Frequency Mode

All DTF measurements are made with frequency settings and, using Inverse Fast Fourier Transform (IFFT), the time and distance to faults are calculated.

NOTE The start and stop frequencies for the measurement are always annotated on the screen below the start and stop distances.

How to set Frequency Mode

With a DTF measurement present,

- Press **Meas Setup 4**
- Then **Frequency Mode**
- Choose one of the following:
 - **Lowpass Mode** The frequency range of a DTF measurement is set automatically based on the Start and Stop Distances. Use Lowpass mode when the DUT is a cable ONLY.
 - **Bandpass Mode** (Default setting) The frequency range of a DTF measurement is set manually. Use Bandpass mode when the DUT contains a diplexer or other filtering device which does not pass some frequencies.

Typically, you will set the frequency range of the measurement to the passband of the filter. However, you may also want to test the ability of the filter to **reject** unwanted frequencies. In this case, set the frequency range to include those frequencies which the filter may not be adequately rejecting.

When the DTF frequencies are set manually, they may not be the optimum frequencies for measuring the distance to fault. The distance may no longer be alias-free. Learn more about alias-free range on page 61.

How to manually set Frequencies in Bandpass Mode

- Press **Freq/Dist**
- Then **Min Start Freq** and type the start of the frequency range to use for the DTF measurement.
- Then **Max Stop Freq** and type the stop frequency to use for the DTF measurement.
- OR
- Press **More**
- Then **Max Freq Span** and type the frequency range to use for the DTF measurement.
- Then **Center Frequency** and type the center frequency of the range to use for the DTF measurement.

These settings specify the minimum and maximum frequencies to be used for the DTF measurement. These exact frequencies may not be used, but a narrower frequency range may be used that will still pass through the bandpass filter.

To see the frequencies that are used in the DTF measurement, press **Meas Setup 4** then **Settings** then **Next Page**. The calculated Start and Stop frequencies determine the exact frequency range being used.

Coupled Frequency

When both a DTF and non-DTF measurement are present, this setting allows you to have different frequency ranges for each measurement. Learn more on page 50.

Cable (Correction) Specifications

By default, the FieldFox does NOT correct DTF measurements to account for the inherent loss of a cable. However, to make more accurate DTF measurements, the Cable Loss and Velocity Factor values should be considered.

About Velocity Factor and Cable Loss

- Velocity Factor is a property of the physical material of a cable. A VF of 1.0 corresponds to the speed of light in a vacuum, or the fastest VF possible. A polyethylene dielectric cable has VF = 0.66 and a cable with PTFE dielectric has VF = 0.7.
- Cable Loss is specified in dB/meter. In addition to the length of the cable, loss is also directly proportional to the frequency of the signal that passes through the cable.

The following is an example showing how DTF cable correction works:

The DUT is a 100 meter transmission cable. The Cable Loss value is .1 dB/meter. This means that a signal traveling ONE WAY through the cable will lose 10 dB of power (100 m * .1dB/m). Because the FieldFox performs this measurement with 1 port, the test signal travels down the cable and then back, for a total loss of 20 dB.

After a calibration has been performed, for the purpose of illustrating this point, connect an OPEN to the end of the cable – a maximum-sized fault – for 100% reflection of the 300 MHz test signal.

Without compensation for the loss of the cable, a –20 dB response would be visible at 100 meters, which is the OPEN at the end of the DUT. This is from 10 dB of loss through the cable in each direction.

With compensation for the loss using the manufacturer’s specification, the FieldFox compensates the trace as though the signal traveling through 100 meters was increased by +20 dB. Therefore the response will show 0 dB for 100% reflection.

How to enter Cable Loss and Velocity Factor

Cable Loss and Velocity factor can be entered using one of the following methods:

- Manually enter cable loss and velocity factor for the measurement.
- Select or create a cable file which contains the cable loss and velocity factor.

With a DTF measurement present:

- Press **Meas Setup 4**.
- Then **DTF Cable Specifications**
- Select **Cable Corr**
 - **Auto** Use Cable Loss and Velocity Factor values from a Cable file. See “How to Edit, Save, and Recall a Cable File” below. This will overwrite a manually-entered value.
 - **Man** Manually enter a value for Cable Loss and Velocity Factor.
- Then:
 - **Velocity Factor** Using the numeric keypad, enter a value between 0.01 and 1. Then press **Enter**.
 - **Cable Loss** Using the numeric keypad, enter a positive Cable Loss value in dB/m, then press **Enter**.

How to Edit a Cable File

The FieldFox includes many predefined cable files with the manufacturer’s specifications. You can edit these files or create new cable files using the following procedure or using the FieldFox Data Link Software. Learn more at:

www.keysight.com/find/fieldfoxsupport

The Cable correction data survives a Mode Preset and Preset.

With a DTF measurement present:

- Press **Meas Setup 4**
- Then **DTF Cable Specifications**
- Then **Edit/Save/Recall Cables**
- Press **New** then **Yes** to clear all data from the existing DTF Cable table and reset header information to default settings.
- Then **Edit Cable** to open the Cable Editor.
- Then use the **▲▼** arrows to select a field,
 - When editing Cable Description information, press **Edit** then modify the selected field using the FieldFox labeler.

- When editing Frequency/Loss pairs, enter numbers using the numeric keypad, then select a frequency suffix. Then **Enter**. Learn more about “How the Freq/Loss pairs are applied” below.
- Optionally choose from the following:
 - **Previous / Next Page** Quickly scrolls through pages of Freq/Loss data.
 - **Add Data** Add a blank Freq/Loss pair to the table,
 - **Delete/Clear** then:
 - **Delete Line** Remove the selected Freq/Loss pair from the table.
 - **Clear All** then **Yes** Remove all Freq/Loss pairs from the table and resets header information to default settings.
- Press **Done** to close the Cable Editor.

How to Save or Recall a Cable

- Press **Save Cable** to save your changes to the specified Storage Device. Enter a filename using the FieldFox labeler (learn more on page 124). Learn more about Cable files below.
- Press **Recall Cable** to load a Cable file from the specified Storage Device.
- **Storage Device** Changes the device used to save or recall Cable files. This is a different setting from the Storage Device setting on the Save/Recall menu. Choose from **Internal** (default setting), **USB** (must be connected) or **SD card**.

About Cable files

- Cable files are saved to, and recalled from, the **Cables** folder. If the folder does not already exist on a USB or SD card, it is created automatically before storing the file.
- Cable files are stored as *.xml files. Existing cable files that are preloaded into the FieldFox firmware can be overwritten. Your edited file will NOT be overwritten when firmware is updated.

How the Freq/Loss pairs are applied

When the cable file contains one Freq/Loss pair, that correction value is applied to the entire displayed frequency span.

When the cable file contains two or more Freq/Loss pairs, the Loss value that is used is interpolated from the Freq/Loss pairs and the DTF center frequency. For example, using a cable file with the following Freq/Loss pairs:

1 GHz: 0.1 dB/m

2 GHz: 0.2 dB/m

The center frequency for the measurement is determined from the calculated (Stop – Start) frequency values (seen on the second page of DTF Settings):

Calculated Start = 2.0 MHz

Calculated Stop = 3.598 GHz

Center Freq = 1.80 GHz

The Loss value for the measurement is interpolated from the Freq/Loss pairs at the Center Freq:

1 GHz = 0.1 dB/m

1.8 GHz = 0.18 dB/m

2 GHz = 0.2 dB/m

The correction for loss at 5 meters in one direction: $0.18 \text{ dB/m} * 5\text{m} = 0.9 \text{ dB}$.

All DTF measurements correct for loss for travel down the DUT and back, so double the correction: $0.9 \text{ dB} * 2 = 1.8 \text{ dB}$.

Window Settings

Window settings provide the ability to choose between optimizing DTF measurements for resolving closely-spaced faults or for the ability to measure low-level faults.

How to select Window settings

- Press **Meas Setup 4**.
- Then **Settings**.
- Then press **▲▼** arrows to move to the Window row.
- Then press **Edit**.
- Then press **Window** repeatedly and choose from the following:
 - **Maximum – Optimized for dynamic range**, the noise floor is lowered to provide the ability to measure low-level responses. (Default setting)
 - **Medium** – Compromise between Min and Max window settings.
 - **Minimum – Best Response Resolution**, providing the ability to resolve between two closely-spaced responses.
- Then press **Done Edit**.
- Again press **Done**.

DTF Units

The DTF Units setting is available ONLY on the DTF Settings table.

By default, X-axis units for DTF measurement settings are displayed in Meters.

How to change DTF units

- With a DTF measurement present, press **Freq/Dist**.
- Then **DTF Units**.
- The current selection is underlined **m (meters) Feet**.

Calculated DTF values

Press **Next Page** on the DTF Settings Table to view the following **calculated Values** noted on the FieldFox screen with c - <setting>

Start Frequency – Start frequency that is used to calculate DTF.

Stop Frequency – Stop frequency that is used to calculate DTF.

Range Resolution. Indicates the accuracy of the distance to fault measurement. For example, with range resolution of 500 mm, if the distance to fault is 10 meters, this value could be inaccurate by +/- 500 mm or between 9.5 to 10.5 meters. This value is calculated from frequency span / resolution (points).

Response Resolution, not displayed, indicates the distance that could be between two faults and still show as separate faults. Learn more in Window Settings on page 57.

Maximum Distance. The distance that could be viewed with the current settings. Defined by: $Vf * c * Points / (2 * Bandwidth)$ where:

- Vf = velocity factor
- c = speed of light
- Points = resolution
- Bandwidth = frequency range

Alias-free Range (On/Off)

- On = No Alias images
- Off = Alias images may appear in the response.

About Alias Faults

An alias fault is not a true device response. An alias fault appears because of the method used to convert frequency to time.

On the DTF Settings page (above) the **c - Alias-free Range = Off** setting indicates alias images MAY appear on the screen.

Shorter stop distances (less than 10 meters) and a higher resolution (1001 points) will be **more** likely to result in **Alias-free Range = Off**.

When the Alias-free Range = Off, the following procedure will help to determine if a response is true or an alias response:

1. Put a marker on the response in question and note the distance to the fault.
2. Change the start or stop distance.

A true fault response will not move in distance. That is, if a true fault is present at 10.3 meters, changing the stop distance from 15 m to 20 m will not move the fault; the fault will remain at 10.3 meters. However, an alias response will appear to move.

An un-terminated cable (with NO perfect load at the end) will show faults that appear to be beyond the end of the cable. These are NOT alias faults. These faults appear as the signal reflects off the open at the end of the cable and travels back down the cable toward the connection at the FieldFox. Re-reflections are measured at the FieldFox as mirror images of the original faults. The largest fault is the open end of the cable. To avoid confusion, set the Stop distance shortly after that fault.

Calibration for NA, CAT, and VVM Modes

Calibration removes the systematic errors that are associated with measurements in NA, CAT, and VVM Modes. Key presses are identical in all of these Modes.

In this Chapter

Why and When to Calibrate	62
Definitions	62
CalReady	63
How to Perform a Calibration	63
QuickCal	64
Mechanical Cal	66
ECal	68
Simple Response Cal	69
View Cal	70
Calibration Type	70
Isolation Step of a 2-port Cal	72
Waveguide Calibrations	73
Enhanced Response Optimization	73
Interpolation	73
Questionable Accuracy	75
Compatible Mode Calibrations	75
Save a Calibration	75
CalReady Properties	75
Verify Calibration	76
Calibration Method Summary	77

See Also

Learn **How to Make 75 ohm Measurements** at the FieldFox Supplemental Online Help: <http://na.support.keysight.com/fieldfox/help/FieldFox.htm>

Why and When to Calibrate

There are well-defined and understood systematic errors that are measured and calculated during the calibration process. These errors are caused by leakage signals inside the FieldFox, by the frequency response of the FieldFox receivers, and by reflections inside the FieldFox that interact with the DUT. After calibration, these errors are removed from subsequent measurements.

To maintain highest measurement accuracy, perform a new calibration when any of the following changes occur:

- When any of the following measurement settings change: Frequency Range, Power Level, IF BW, and Resolution. Therefore, make these measurement settings before calibrating. Increased Averaging, lower IF BW, and higher Resolution all cause slower sweeps and slower calibration times. Learn about Interpolation and Questionable Accuracy on page 73.
- When the FieldFox temperature changes more than about 10°F (5°C). Learn how to monitor the internal temperature on page 14.
- When the connection to the DUT changes, requiring a different jumper cable or adapter.

Definitions

DUT (Device Under Test) The cable, antenna, transmission line, amplifier, or anything else that is connected to the FieldFox that is to be measured.

Calibration Standards – OPEN, SHORT, LOAD, and THRU

- **OPEN, SHORT, and LOAD** are ‘reflection’ standards that are used during calibration. When an RF signal ‘hits’ these components, the signals are reflected in a predictable manner. These components can also be used to terminate a DUT port during some measurements.
 - SHORT and OPEN standards both cause 100% of an RF signal to be reflected. The difference between these two standards is what happens to the phase of the reflected signal, which is beyond the scope of this discussion. Although an OPEN standard is a precision component, simply leaving **nothing** connected at the end of a cable can be a reasonable substitute for an OPEN.
 - A LOAD standard absorbs almost ALL of the incident signal and very little signal is reflected back to the source.
- A THRU standard is used during some calibration steps to connect PORT 1 to PORT 2 in place of the DUT. A Flush THRU connection can be made when cables that connect with the DUT can mate with each other. Learn more on page 70. Otherwise, any reasonably short cable can be used as a THRU standard.

Calibration Reference Plane is the point (or points) at which the DUT and cal standards are connected during a calibration. This can be at the FieldFox test port connectors, or at the end of jumper cables or adapters.

CalReady

Every FieldFox contains a factory calibration that was performed at the port 1 and port 2 connectors over the entire frequency range of the FieldFox using a number of data points that allows reasonable interpolation over the FieldFox frequency range. This calibration, known as CalReady, allows you to immediately make accurate measurements for a DUT that is connected directly at the test ports (PORT 1 and/or PORT 2). CalReady corrects measurements when the FieldFox is turned ON, when Preset is pressed, and when a measurement is created with no other correction in place.

When measuring a DUT using a jumper cable or adapter – NOT a direct connection to a test port connector – then for highest accuracy a QuickCal or Mechanical Cal is recommended. CalReady can also be used to check the integrity of the jumper cable that is attached to the test ports.

CalRdy is shown when a measurement is corrected using CalReady.

You can change the properties of the CalReady calibration. Learn more on page 75.

Learn how to see when your factory CalReady calibration was performed on page 144.

How to Perform a Calibration

- In CAT, NA, or VVM Mode, press **Cal 5**.

The following appears:

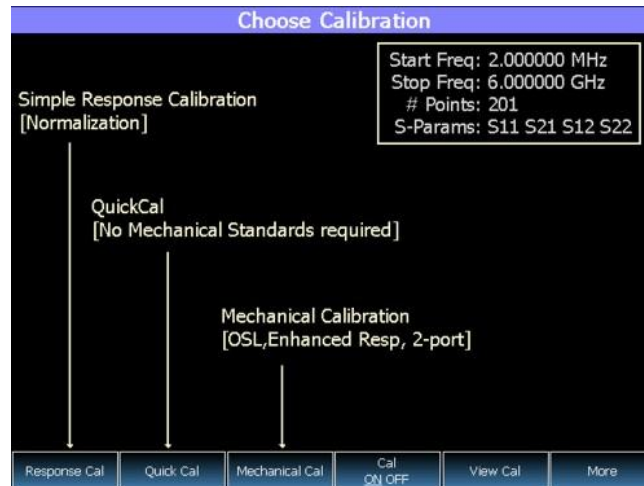

Choose Calibration Method screen

Response Cal – Used to quickly calibrate ONE measurement using mechanical standards. Measurement accuracy is generally low. Learn more on page 68.

Quick Cal (Option 112) – Using built-in cal standards, quickly and accurately cal measurements when using a jumper cable or adapter to connect the DUT to the FieldFox test ports. Learn more on page 64.

Mechanical Cal – Using mechanical cal standards from a cal kit, perform an accurate calibration at one or both test ports, adapters, or jumper cables. Learn more on page 66.

User Cal OFF ON – Turns ON and OFF the effects of a calibration that you performed. The OFF state reverts to CalReady which can never be turned OFF.

View Cal – Shows the properties of the current calibration. Learn more on page 70.

More – Learn about CalReady Properties on page 75.

NOTE Press **Esc** at any time to end the calibration process.

QuickCal (Option 112)

QuickCal is ideal for a quick and simple calibration of the measurement when using a jumper cable or adapter to connect the DUT to the FieldFox test ports. QuickCal corrects for phase shift, time delay, and loss of adapters or jumper cables.

QuickCal does not require a specific Cal Kit and is a very simple calibration. If the highest accuracy is required, a mechanical calibration with a high quality calibration kit is recommended.

QuickCal is designed for DUTs fitted with **Type-N and 7/16** connectors.

If the DUT has different connectors, such as 3.5 mm (male) or SMA male connectors, QuickCal can still be used by selecting 'Other' connector. However, the accuracy of QuickCal with 'Other' connectors is not specified.

If the DUT has 3.5 mm-female or SMA-female connectors, QuickCal is NOT recommended. For accurate and repeatable measurements of devices with female 3.5 mm or SMA connectors, use mechanical calibration.

Important QuickCal Notes

- 7/16 connectors can be used with QuickCal ONLY up to 6 GHz.
- Type-N 75 Ohm can be used with QuickCal ONLY up to 3 GHz.

- QuickCal cannot be used with waveguide, or if the test fixture or test setup (before DUT) includes an attenuator.
- During QuickCal, the frequency range of the measurement MAY be extended to provide maximum flexibility.

How to perform a QuickCal

- In CAT, NA, or VVM Mode, press **Cal 5**.
- Then **QuickCal**
 - Press **Change DUT Connectors** to select the correct connector types that are on your DUT. Although there is no Cal Kit required, selecting the connector type and gender from the list provides an accurate OPEN model which means a more accurate calibration. If the DUT connector type is not listed, select **Unknown/Other**.
 - The connector choices that are offered depend on the frequency range. For example, if you have selected a frequency range that exceeds 18 GHz, the only connector options you will be presented with in QuickCal are 'other 50 ohm' or 'other 75 ohm'. This is because 3.5 mm connectors, which go beyond 18 GHz, are not supported with QuickCal.
- For each DUT port:
 - Select the connector type of the DUT using the **▲▼** arrows or rotary knob.
 - Press **Change Gender** to change the gender of the DUT connector.
 - Then press **Next...** to make the selection.
- **Select/Change Cal Type.** The FieldFox always RECOMMENDS a Cal Type that will quickly and accurately calibrate all of the displayed S-parameters. The other Cal Types that are listed will NOT necessarily calibrate all of the displayed S-parameters. Learn more about Cal Types on page 70.
 - Using the **▲▼** arrows or rotary knob, select a Cal Type, then press **Select and Finish**.
- Press **Start Calibration**

No Connection

- Disconnect the DUT from the FieldFox.
- If a jumper cable or adapter is required to connect the DUT to the FieldFox, connect those components to the FieldFox test ports connectors. The effects of those components will be measured and removed during the calibration, and only the effects of the DUT will be displayed in the measurement results. These should be high-quality components!
- Do NOT connect anything at the cal reference plane where the DUT connects.
- Press **Measure**

Optionally Connect Load(s)

- Connect a Load standard at the point where the DUT will be connected and press **Measure** under the following conditions:

- When a jumper cable has too much loss. If a 'Cal Failed' error appears and you skipped the Load measurement, then perform the Cal again but measuring the Load.
- When your DUT has high return loss such as the reject band of a filter. Then measuring the load improves accuracy. Even with the optional Load, phase accuracy begins to degrade when the return loss is greater than about 20dB.
- Press **Skip Step** in all other cases and when making DTF measurements. Measuring a load would do little to improve accuracy.

Connect THRU (Not used for 1-port cals)

- Connect port 1 to port 2, either by mating the connectors that attach to the DUT (Flush THRU), or by using a short jumper cable. Learn more about Flush THRU on page 70. Then press **Measure**.
- Press **Finish**.

CAL ON Q is shown on the screen for all displayed measurements that are corrected with QuickCal.

Using QuickCal with a Long Jumper Cable

QuickCal requires a sufficient frequency span to adequately characterize the jumper cable (the cable between the instrument port and the DUT). If a 'Cal Failed' error appears and you connected the optional Load standard, then increase the frequency span of the measurement until the error no longer appears. After the calibration, you can then decrease the frequency span as needed and rely on interpolation. Learn more about Interpolation on page 75.

QuickCal is also limited in how much jumper cable loss it can tolerate. If QuickCal without the load is failing, then measure the load during the QuickCal to see if that resolves the issue.

Mechanical Cal

Mechanical Calibration is performed using discrete standards from a Cal Kit. Several Cal Kit definitions are built into the FieldFox.

NOTE Visit www.keysight.com/find/fieldfoxsupport to see a complete list of supported Cal Kits. Also at this website, download DataLink software that allows you to edit Cal Kit definitions or add a new Cal Kit.

Mechanical Cals are extremely accurate when performed using the correct Cal Kits with standards that are clean and in good repair, and when using correct connection procedures.

How to perform a Mechanical Cal

- Disconnect the DUT from the FieldFox.
- If a jumper cable or adapter is required to connect the DUT to the FieldFox, then connect **those** components to the FieldFox connectors. The effects of those components will be measured and removed during the calibration, and only the effects of the DUT will be displayed in the measurement results. **These should be high-quality components!**
- In NA, CAT, or VVM Mode, press **Cal 5**.
- Then **Mechanical Cal**

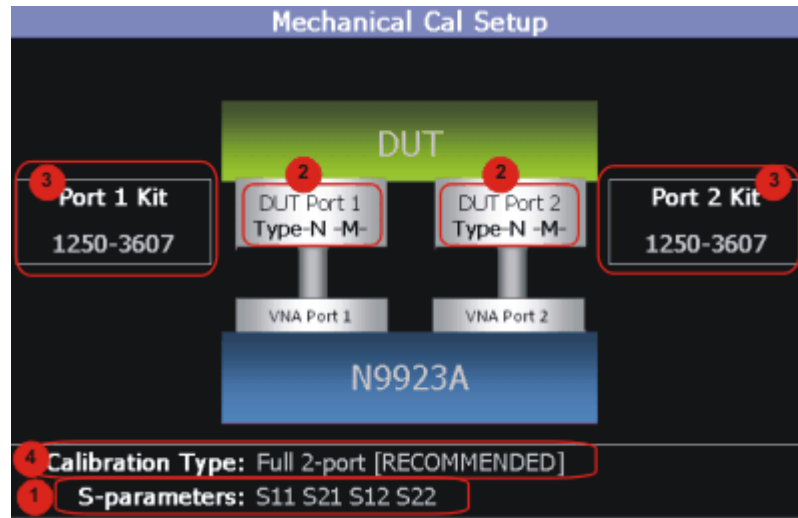

This page summarizes the Mechanical Cal to be performed and allows you to make changes. For best results, review the screen and make changes in the following order:

1. **S-parameters** – Verify that these are all of the S-parameters that you want calibrated. If not, press **Esc** to terminate the calibration process, then return to the Trace menu to display all of the traces to be calibrated. Learn how on page 23.
2. **DUT Connectors** – For each DUT port that is shown, verify the correct type and gender of the DUT connector. If a DUT port is not shown, then that port is not included in the list of S-parameters to be calibrated.
3. **Cal Kit** - Verify the correct Cal Kit for each DUT port to be calibrated. See a list of supported Cal Kits in the FieldFox data sheet. See page 162.

If the DUT connector type, gender, or Cal Kit is **NOT** correct for the DUT ports to be calibrated, then:

- Press **Change DUT Connectors** to select the correct connector types that are on your DUT.
 - For each port:
 - Use the **▲▼** arrows or rotary knob to change the DUT connector type.
 - Press **Change Gender** to change the gender of the DUT connector.
 - Then press **Next...** to make the selections.
 - For each port:
 - Use the **▲▼** arrows or rotary knob to select the Cal Kit that you have, and are going to use, for the specified ports.
 - Then press **Next...** to make the selection.
4. **Calibration Type** - The FieldFox always RECOMMENDS a Cal Type that will quickly and accurately calibrate all of the displayed S-parameters. Change from the RECOMMENDED Cal Type ONLY if you understand the implications. Learn more about Cal Types on page 70.
To select a different Cal Type:
 - Press **Change Cal Type**.
 - Then using the **▲▼** arrows or rotary knob, select a Cal Type,

- Then press **Select and Finish**.

Begin Calibration

- Press **Start Calibration**.

NOTE If an error appears (“**Failure to compute calibration steps...**”), check to ensure that the frequency range of the Cal Kit covers the frequency range of the measurement. You can verify the frequency range of your Cal Kit at: www.keysight.com/find/fieldfoxsupport. Click **Cal Kits**.

Follow the Cal Wizard prompts. Connect the specified standard at the point where the DUT will be connected, then press **Measure**.

At any time, press **Back** to Re-Measure a standard if you feel it was not properly connected.

Press **Finish** to complete the calibration.

CAL ON U is shown on the screen for all displayed measurements that are corrected with the Mechanical Cal.

ECal

ECal is a complete solid-state calibration solution. Every ECal module contains electronic standards that are automatically switched into position during a calibration. These electronic standards have been measured at the factory and the data stored within the memory of the ECal module. The FieldFox uses this stored data, along with the measured data, to calculate the error terms for a measurement calibration.

You can perform the following calibrations with ECal:

- 1-Port Reflection calibration
- Full 2-Port calibration

All Keysight USB ECal modules are supported. ECal modules are available in a variety of connector types, covering many frequency ranges. For information about available ECal modules, see <http://www.keysight.com/find/ecal>

Select an ECal module that has connectors of the same type and gender as the DUT. If such an ECal module is not available, a module with connectors different from the DUT can be used by selecting a User Characterization. However, a User Characterization can NOT be PERFORMED using the FieldFox. It must be performed using a bench top Keysight VNA, such as the PNA or ENA. Learn more about User Characterization at the PNA Help website:

http://na.support.keysight.com/pna/help/latest/S3_Cals/ECal_User_Characterization.htm.

How to Perform a Calibration Using ECal

- Make measurement settings on the FieldFox (frequency range, number of points, etc.)

NOTE The frequency range of the measurement MUST be within the frequency range of the ECal module or an error will appear when “Calculating Steps” during the calibration.

- Connect the ECal module USB cable to the FieldFox USB.
- Allow the module to warm up until it indicates **READY**.
- Connect the ECal module ports to the FieldFox at the calibration reference plane (where the DUT will be connected).

- Press **Cal 5** to start the Calibration.
- Press **Mechanical Cal / ECal**
- Press **Change DUT Connectors**. For each test port to be calibrated, select the **Connector Type** and **Gender** of the DUT / ECal module. The connected ECal module and relevant User Characterizations will appear as the default Cal Kit.
- Optionally press **Advanced** then **ECal Auto Orient**.
 - **ON** (default) The FieldFox automatically senses the direction in which the ECal module ports are connected to the FieldFox ports.
 - **OFF** If power to the ECal module is too low, it cannot detect which FieldFox ports it is connected to. If you are having this problem, select OFF. Then during the calibration, the FieldFox will prompt you to connect the ECal module ports to specific FieldFox ports.
- Optionally press **Advanced** then **Simple ECal**.
 - **ON** (default) The FieldFox assumes that both ports of the ECal module can be connected at both calibration reference planes. You therefore receive a single prompt to connect the ECal module to both ports.
 - **OFF** Select when physical restrictions prohibit the ECal module from being connected to both calibration reference planes simultaneously. You will receive separate prompts to connect the ECal module to Port 1, then to connect the ECal to Port 2.
- Press **Start Calibration**. When prompted, connect the ECal module, then press Measure. The standards within the ECal module are automatically connected and measured.

NOTE

When prompted: **"Connect port 1 to port 2"**, then you can connect them however you choose, including using the internal ECal THRU. This is an 'Unknown THRU'.

When prompted: **"Connect port 1 directly to port 2"**, then you must connect the ports directly together at the calibration reference plane with no adapter or other cabling. This is a 'Flush THRU'.

Learn more on page 71.

Simple Response Cals

Simple Response Cals are used to quickly calibrate the magnitude and phase of a measurement using any Open, Short, or Thru component. These may be calibration standards, but because a Cal Kit is not selected, they are not modeled. Measurement accuracy is generally low. Use a Simple Response Cal to make quick measurements when using a jumper cable to connect the DUT to the FieldFox. Otherwise, CalReady is usually more accurate.

NOTE You can perform a Simple Response Cal for either: S11, S22, or S21 AND S12.

When prompted, choose a standard based on the displayed measurements to be calibrated. For example, to calibrate S11, connect either an OPEN or SHORT standard to the port 1 reference plane.

1-port response cals are also available from the Mechanical Cal menu. Learn more on page 72.

Normalize uses a THRU standard or cable between port 1 and port 2 to cal an S21 and S12 Transmission measurement (NA Mode) and a 2-port Insertion Loss measurement (CAT Mode). In VVM Mode, this is performed using **Zero**.

How to perform a Response Cal

- Select the measurements to be calibrated. See the relevant Mode (NA, CAT, or VVM) for measurement selections.
- Press **Cal 5** then **Response Cal**
- For 1-port measurements:
 - Select either **Open Response** or **Short Response** for the port to be calibrated. Port 2 is available only with Option 122.
 - Connect an OPEN or SHORT standard to the specified port and press **Measure**
- For 2-port measurements:
 - Select **Normalization**
 - Connect a short, high-quality, phase stable cable between the FieldFox port 1 and port 2 connectors, then press **Measure**

NOTE With a Normalization Cal, all subsequent insertion loss measurements are made relative to the insertion loss of the THRU cable. For example, if you use a cable with 1 dB of loss, then after Normalization, the display will show 0 dB of loss with this cable in place. Therefore, for highest accuracy, when measuring the DUT also attach the cable that was used in the normalization cal.

- Press **Finish**.
- Connect the DUT.

CAL ON U is shown on the screen when a Response Cal is correcting ONLY the appropriate measurement.

View Cal

From the **Choose Calibration** screen (page 63), press **View Cal** to see the following screen:

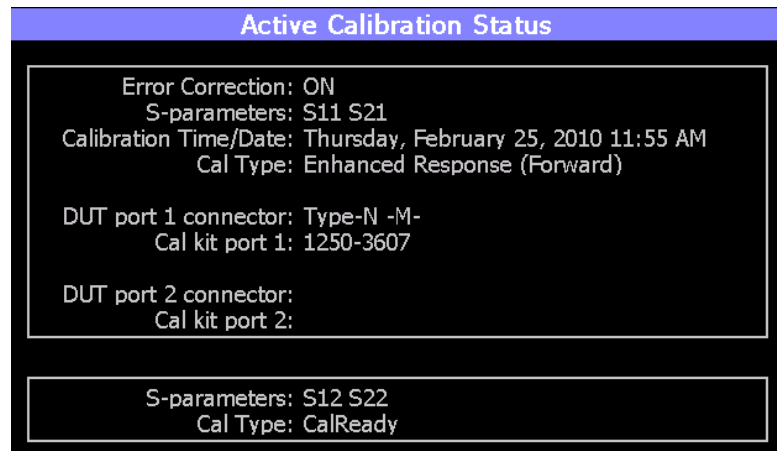

The top box shows the properties of the current calibration that you performed and the displayed S-parameters that it is correcting.

The bottom box shows the S-parameters that are displayed but NOT corrected by the current performed calibration, but rather the CalReady calibration. Learn more about CalReady on page 63.

Calibration Type

The FieldFox simplifies the calibration process by recommending the most accurate and efficient calibration type based on the displayed S-parameters.

However, there may be times when you may want a little more accuracy or a little faster sweep time. The following information can help you learn about the various calibration choices.

Definitions:

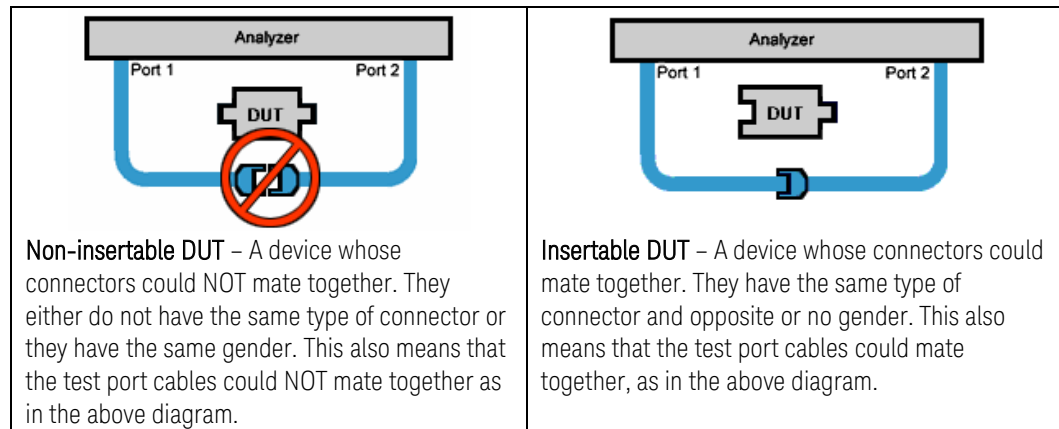

Defined THRU – A THRU standard for which there is a Cal Kit definition such as in the 8551xA Cal Kits.

Flush THRU – When the test port cables mate together when measuring an Insertable DUT. Flush THRU is also a Defined THRU with a definition of zero loss and zero length.

Sweep Directions – Both FULL 2-Port Cals listed below result in correction that requires background measurements sweeps in both directions, regardless of the displayed measurements. The displayed traces are updated at a slower rate than Enhanced Response and 1-port calibrations, which require sweeps in one direction only.

1-Port (OSL)

DUT: Not Applicable
 S-parameters Corrected: S11 or S22
 Standards: OPEN, SHORT, LOAD
 Sweeps in ONE direction.

FULL 2-Port (Requires Option 122).

Most comprehensive calibration. Corrects all S-parameters.
 DUT: Non-Insertable or Insertable
 Standards: OPEN, SHORT, LOAD on **BOTH** ports. Any THRU between ports.
 For more information on the Unknown Thru process, see the FieldFox Supplemental Online Help:

<http://na.support.keysight.com/fieldfox/help/FieldFox.htm>

Sweeps in BOTH directions.

FULL 2-Port (QSOLT) – Mechanical Cal ONLY (Requires Option 122)

Quicker to perform than Full 2-port. Corrects all S-parameters.

DUT: Insertable only

Standards: OPEN, SHORT, LOAD on port 1. Flush THRU between ports.

Sweeps in BOTH directions.

Enhanced Response Cal – Forward OR Reverse (May require an option)

Faster measurements than Full 2-Port.

DUT: Non-Insertable or Insertable

S-parameters Corrected: S21 and S11 (Forward) **OR** S12 and S22 (Reverse)

Standards: OPEN, SHORT, LOAD on **ONE** port. Defined THRU between ports.

Sweeps in ONE direction.

NOTE Also select an Enhanced Response Optimization. Learn more on page 73.

TRL – Mechanical Cal ONLY.

Potentially better accuracy than Full 2-port. Corrects all S-parameters.

DUT: Non-Insertable or Insertable

Standards: Thru, Reflect, Line or variations of these. A TRL Cal Kit **MUST** be selected to see this Cal Type.

Sweeps in BOTH directions.

Learn more about TRL Calibration in the **Supplemental Online Help:**

<http://na.support.keysight.com/fieldfox/help/FieldFox.htm>

1-port Response Cals (Open or Short)

Calibrate the magnitude and phase of a measurement using 'modeled' mechanical standards. Measurement accuracy is better than Simple Response Cals (available on the main Cal page) but **NOT** as good as full 1-port cal. Corrects either S11 or S22. Can be used with Isolation (see following section). Learn more about Simple Response Cals on page 69.

DUT: Non-Insertable or Insertable

Standards: OPEN or SHORT on **ONE** port.

Sweeps in BOTH directions.

Isolation Step of a 2-port Cal

The optional isolation step of a 2-port calibration corrects for crosstalk which is the internal signal leakage between the test ports. The additional Isolation step measures Load standards that are connected to both FieldFox test ports.

Perform an isolation calibration when you are testing a device with high insertion loss, such as the stop band of a filter or a switch in the open position.

The isolation step can add noise to the error model when the measurement is very close to the noise floor of the analyzer. To improve measurement accuracy, set a narrow IF Bandwidth during the calibration.

The Isolation step is **NOT** allowed with ECal or QuickCal.

How to perform the additional Isolation step

With a 2-port measurement selected:

- Press **Cal 5** then **Mechanical Cal / ECal**
- Then **Advanced**
- Then **Omit Isolation**
 - **OFF** Perform the Isolation step
 - **ON** (default) Omits the Isolation step
- Then **<Back**
- Configure and perform the calibration as usual. At the first step of the Cal you will be prompted to connect a Load standard to each test port.

NOTE If the first calibration step does NOT prompt you to connect Load standards to each port, then the Cal Kit probably does not contain an Isolation standard. You can use DataLink software to edit the Cal Kit and add an isolation standard using a Load standard. See Data Link Help for more information:
<http://na.support.keysight.com/fieldfox/help/DataLinkHelp/DataLink.htm>

- This setting survives an Instrument Preset.

Waveguide Calibrations

In general, calibrating with Waveguide is very similar to calibrating with coax. However, most coax mechanical Cal Kits have standards that can be used over a very wide frequency range. Waveguide Cal Kits are used over a narrow frequency range. Therefore, it is VERY IMPORTANT to set the frequency range of the measurement WITHIN the frequency range of the waveguide Cal Kit. Otherwise, an error message will appear during the 'Calculating Steps' portion of the calibration.

Waveguide Cal Kits

Keysight sells two waveguide Cal Kit series: the premium 11644A series and the economy N9911X series. Both are available online at www.keysight.com

Effective Velocity Factor

Velocity factor is the speed at which an electromagnetic signal passes through the transmission medium relative to the speed of light. This value is important when distance is being calculated in DTF measurements (CAT mode) and Time Domain (NA mode).

When the media is waveguide, the velocity factor changes with frequency. FieldFox calculates this 'effective' velocity factor automatically. However, the settings are different for CAT mode and NA mode.

CAT Mode - How to make Waveguide settings

These settings are necessary ONLY when making DTF measurements.

- Press **Measure 1** then select a DTF measurement.
- Press **Meas Setup 4**
- Then **Settings** (Learn how to use the Quick Settings table on page 25.)
- Set **Media = Waveguide**. Frequency Mode = **BandPass** is automatically selected for you.
- Scroll down to **Waveguide Definitions**. Select the **Waveguide Standard** being used. If your waveguide standard is NOT listed:
 - Select **User Waveguide**. Then press **Done**.

- Then **DTF Cable Specifications**, then **Edit/Save/Recall Cables**, then **Edit Cable**.
- Scroll to set **Waveguide Definition** and set **VF Corr** = Auto.
- Then set the **Min, Max, and Cutoff Frequencies**.
- Set **Cable Correction** = **Auto**. The Effective Velocity Factor is calculated automatically based on the frequencies of the waveguide standard. To override this setting, set Cable Correction = **Man**.

NA Mode - How to make Waveguide settings

These settings are necessary ONLY when your measurement requires electrical delay or port extensions, or if using Time Domain Transform.

- Press **Meas Setup 4**
- Then **Transform**
- Then **Transform Settings**
- Under **Transform Stimulus Settings**, set the **Start** and **Stop** frequencies to those of the Waveguide.
- Set **Stimulus** = **Bandpass Impulse**
- Press **Meas Setup 4**
- Then **Calibration Settings**
- Set **Media** = **Waveguide**
- Set **Cutoff Frequency**. This is the absolute minimum frequency of the waveguide. This value must be less than the Start Frequency of the Waveguide.
- Enter the calculated **Effective VF** value into the Velocity Factor setting.

Enhanced Response Optimization

When Enhanced Response Cal Type is selected, either for one calibration or for CalReady, this setting optimizes the calibration based on the type of DUT being measured. See also: CalReady Properties on page 75.

This setting does NOT survive Preset.

- Press **Cal 5** then **More**
- Then **Enh.Response**
- Then choose from:
 - **Non-Reciprocal** (default) An amplifier is a Non-Reciprocal device because it has gain in the forward direction, and very high loss (isolation) in the reverse direction. This choice provides the best correction for non-reciprocal devices, and reasonable correction for reciprocal devices.
 - **Reciprocal** A reciprocal DUT is a device in which the insertion loss through the device is similar in both the forward (S21) and reverse (S12) directions. A cable is a reciprocal device. This choice provides the best correction for reciprocal devices. However, S11 measurements on non-reciprocal devices will appear to have more return loss than the non-reciprocal choice.

Interpolation *

Highest measurement accuracy is achieved when the frequency range or resolution settings remain the same during the measurement as when the FieldFox was calibrated. If these settings change after performing a calibration, the FieldFox will interpolate the calibration so that VERY accurate measurements continue to be made.

Interpolated Calibrations are only **slightly less accurate** than a calibration performed at the measurement settings. Learn more about the relative accuracy of FieldFox calibrations on page 77.

When a calibration that you performed is being interpolated, an asterisk is added to the Cal annotation. For example: **Cal ON U*** is shown on the screen when the current Response or Mechanical cal is being interpolated. An ***** is never added to a CalRdy.

Cal ON ? – Questionable Accuracy

When the Output Power, Interference Rejection, or IF BW (NA Mode ONLY) setting is changed AFTER performing a calibration, a question mark is added to the Cal annotation. For example: **Cal ON Q?** is shown on the screen when the current QuickCal is being interpolated. An **?** is never added to CalRdy.

The resulting measurement accuracy depends on how much the setting has changed. For highest accuracy, recalibrate using the new settings.

Compatible Mode Calibrations

The FieldFox can have only ONE calibration present for all modes (except CalReady). Calibrating in one mode will overwrite calibrations for other modes.

Because NA, CAT, and VVM modes are very similar, a calibration that is performed in one mode can also be applied in the other modes.

To apply a Cal that was performed in a different mode, press **Cal 5** then select **Cal ON**.

Save the Calibration

After performing any type of calibration, you can save the FieldFox settings along with the calibration into a STATE (*.sta) file. These settings and calibration can then be recalled as necessary. To learn how, see **Saving and Recalling Files** on page 124.

CalReady Properties

There are several factory CalReady calibrations on every FieldFox. These can be selected based on the type of DUT that you measure most often, and the compromise that you prefer to make between measurement speed versus measurement accuracy. Remember, CalReady was performed at the test ports. Therefore, a CalReady calibration is most accurate when the DUT is connected to the test ports. Learn more about CalReady on page 63.

This setting does NOT survive Preset or Power ON/OFF.

- Press **Cal 5** then **More**
- Then **CalRdy**
- Then choose from:
 - **Full 2-Port Cal** – Corrects all four S-parameters. Requires a forward and reverse sweep, which causes slower trace measurements. Learn why on page 70.

- **Enhanced Response** (default) – Corrects forward (S21 and S11) and reverse (S12 and S22) measurements separately. Therefore, when measurements in only one direction are required, this choice provides faster trace measurements than a full 2-port cal. Also choose an Enhanced Response Optimization. Learn more on page 73.

To find the best choice for your DUT:

- Press **Preset** then **Preset**.
- Select the appropriate S-Parameter and other settings (frequency range, resolution, and so forth).
- Press **Trace 6** then **Math and Memory** then **Data->Mem**.
- Press **Data & Memory**.
- Press **Cal 5** then **More**.
- Select a CalReady Cal to compare with the current setting.
- Press **Esc** to exit the cal menu.
- View the differences in the two traces.

Verifying Calibration and Jumper Cable Integrity

After calibrating, it is important to verify that the calibration is good. When using a jumper cable, also verify that the cable is of high quality.

Verify a Calibration

- Connect a LOAD standard at the calibration reference plane (where calibration standards were connected). This may be at the end of the jumper cable or at FieldFox **PORT 1** connector.
- In CAT Mode, select **Return Loss**.
- In NA Mode, select **S11** with Log Mag format.
- Observe the trace on the FieldFox screen:
 - Lower than 35 dB indicates a GOOD calibration.
 - Higher than 30 dB indicates that you should recalibrate.

Verifying Phase Accuracy

- Connect a LOAD standard at the calibration reference plane (where calibration standards were connected).
- In NA Mode, select a S11 Reflection with Polar or Smith Chart format.
- Because all LOAD standards have delay, you should see a small amount of phase rotation as a function of frequency. In general, the measurement result should agree with the characteristics of the calibration standard.

Test the Jumper Cable

With the LOAD standard still connected, move the jumper cable while observing the trace.

- If the measurement trace is relatively stable, the jumper cable is of good quality.

- If you observe significant movement in the peaks of the measurement trace when moving the cable (>5 dB), the jumper cable may need to be replaced.

Calibration Method Summary

- **Mechanical Full 2-port Cal** is ALWAYS the most accurate Cal method. The quality of a Mechanical Cal is completely dependent on the quality of the OPEN, SHORT, LOAD standards and the quality of the standard connections. Use the correct high quality standards to ensure the most accurate calibration.
- **QuickCal** is ideal for DTF measurements. QuickCal should be performed when good accuracy is required and when using a jumper cable or adapter.
 - QuickCal is NOT recommended when the DUT has 3.5 mm-female or SMA-female connectors.
 - Even with the optional Load, phase accuracy begins to degrade when the return loss is greater than about 20dB.
- **CalReady** is accurate ONLY when the DUT is connected at the test ports and most accurate at room temperature.
- **For highest accuracy**, a new QuickCal or Mechanical Cal should be performed:
 - When the temperature changes more than about 10°F (5°C)
 - When the connection to the DUT requires a different jumper cable or adapters.
 - When any of the following measurement settings change: Frequency Range, Power Level, IF BW, and Resolution.

Power Meter Mode

Power Meter measurements, available with Option 302, are made with Keysight USB power sensors. Power readings are displayed on the FieldFox screen.

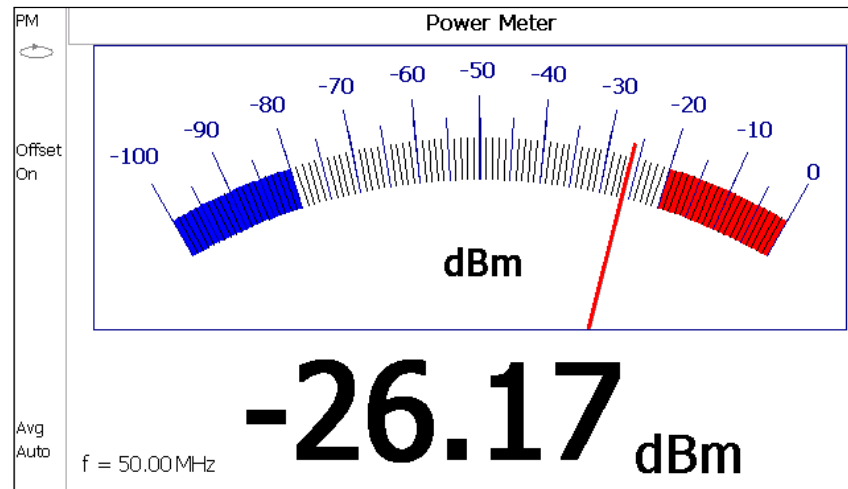

In this Chapter

Supported Power Sensors	78
How to Connect the Power Sensor	78
Average/Peak	79
Zeroing	79
Set Frequency	80
Set Source Control	80
Set Scale	81
Set Relative and Offset Power	81
Set Display Units	82
Set Averaging	82
Single/Continuous	83
Step Detection Mode	83
Set Limits	83

See Also

Frequency Offset using Power Sensor	85
---	----

Supported Power Sensors

For a complete list of supported Keysight USB Power Sensors, please visit:
www.keysight.com/find/usbsensorsforfieldfox

NOTE The FieldFox does NOT support the following Keysight USB Power Sensor features: External Triggering (Time Gated Burst Power Measurement), Power Sweep Operation, and Frequency Sweep Operation. External Zeroing is NOT allowed on the U2020 X-series Power Sensors.

CAUTION

Please refer to your USB Power Sensor User's Guide and observe the damage levels of your device.

How to Connect the Power Sensor

Connect your Power Sensor to one of the USB ports.

NOTE

Use an attenuator between the DUT and the power sensor when measuring power levels that are higher than +20 dBm. The attenuator value can be subtracted from the measurement using the Offset feature, discussed on page 81.

A sequence of status lights are displayed on the base of the power sensor.

- **Green blinking** light indicates the power sensor is communicating or self-tests are being performed. Because the FieldFox is usually communicating with the power sensor when it is connected, this is the normal mode of operation.
- **Amber light** indicates Zeroing is being performed.
- **Red light** indicates an error has occurred with the power sensor. Refer to power sensor documentation.
- **No light** indicates the FieldFox is not communicating with the power sensor. This is the case when in Hold mode or when NOT in Power Meter Mode.

Power Meter Settings

Select Power Meter Mode before making any setting in this section.

How to select Power Meter Mode

- Press **Mode**.
- Then **Power Meter**.

Average / Peak

- Press **Measure 1**
- Then choose from the following:
 - **Average** Measures and reports the average of the power measurements.
 - **Peak** Available ONLY on the U202x power sensors. Measures and reports peak power detected at sensor input.

Zeroing

The Keysight USB Power Sensors perform Internal Zeroing automatically. Because Keysight USB Power Sensors have an internal switch, Internal Zeroing does NOT require that the power source be turned OFF.

For highest measurement accuracy, when measuring power levels below -30 dBm, External Zeroing should be performed.

During External Zeroing, the power source MUST be turned OFF or the power sensor disconnected from the power source (device under test). Power is OFF when power sensor measurements are below -60 dBm. When power higher than this is detected at the sensor, a warning message is shown on the FieldFox and External Zeroing will not proceed.

NOTE

External Zeroing is NOT allowed on the U2020 X-series Power Sensors.

How to perform External Zeroing

- Press **Cal 5**.
- Then **External Zero**.

While either Internal or External Zeroing is being performed, “Zeroing...” is shown on the FieldFox screen. While this message is present, do NOT make any changes to the FieldFox.

In addition, once External Zeroing has started, the power source must be OFF for the entire time that the Zeroing message is present. Otherwise, the calibration will be compromised but NO warning is shown.

Frequency

A table of correction factors versus frequency is stored within the Keysight U2000 Series Power Sensors. The frequency of the power to be measured is entered in the FieldFox so that the appropriate correction factor can be used.

The frequency of the power measurement is NOT limited by the frequency range of the FieldFox, but the frequency range of the power sensor, which can be much wider.

How to enter frequency of the Power Measurement

- Press **Freq/Dist** or **Meas Setup 4**.
- Then **Frequency**.
- Then type a value using the numeric keypad. The default frequency is 50 MHz.
- Then press a multiplier key. Learn about multiplier abbreviations on page 19.

The current frequency is shown on the FieldFox screen.

Source Control

This feature may require an option on some FieldFox models.

With the FieldFox internal source enabled, these settings allow you to make simple, absolute power measurements. The source and the power sensor can be physically separated by a long distance when using a long USB cable.

Set the internal source frequency by setting the frequency of the power measurement. Learn how in the previous section.

Power Meter measurements are limited by the combined frequency ranges of the internal source when enabled and the frequency range of the power sensor. For example, assume the frequency range of your sensor is 9 kHz to 18 GHz and the frequency range of the FieldFox is 2 MHz to 6 GHz.

- With the Source ON, measurements are limited to 2 MHz to 6 GHz.
- With the Source OFF, measurements are allowed from 9 kHz to 18 GHz.

How to set Source Control and Power Level

- Press **Freq/Dist**
- Then **Advanced**

NOTE When Option 208 (FOPS) is enabled, to access Source Control, press **Sweep 3**
Then **Power Setup** Learn more about FOPS beginning on page 85.

- Then **Source Enable**

- **ON** Turn ON the internal source
- **OFF** Turn OFF the internal source

Optionally set the power level.

- Press **Src Nom Power** (0 dBm default setting) Set output power to an arbitrary value at the displayed CW frequency.
- Then enter a value using the numeric keypad, the **▲|▼** arrows, or the rotary knob.
- Press **Enter**

NOTE Amplitude accuracy may be compromised when the Source is ON, Battery Saver is ON, and the Preamp is ON. For highest amplitude accuracy under these conditions, turn Battery Saver OFF. Learn how on page 137.

Scale

The scale of the Power Meter display can be set manually or automatically. The major and minor ticks are set automatically and can NOT be changed. Although the scale settings are limited, you can view measurements beyond these settings by performing Autoscale.

How to Scale the Power Meter display

Manually:

- Press **Scale / Amptd**.
- Then choose from the following:
 - **Scale Min** Sets the low power level of the power meter display. Type a number and select the units or press **Enter**. This value is limited to -100 dBm.
 - **Scale Max** Sets the high power level of the power meter display. Type a number and select the units or press **Enter**. This value is limited to 100 dBm.

Autoscale:

Using Autoscale, the current reading is used for the center of the scale, and Min and Max values are set accordingly.

- Press **Scale / Amptd**.
- Then **More**.
- Then **Autoscale**.

Relative and Offset Power Measurements

Power measurements can be made that are relative to another reading or that are offset by a fixed value.

- Use Relative to measure the difference between power levels.
- Use Offset to account for components or a long length of cable that is used before the power sensor. For example, if using a 10 dB attenuator to protect the FieldFox, enter an Offset Value of 10 to read the power as it would appear without attenuation. If using a 10 dB amplifier, enter an Offset Value of -10 to read the power as it would appear without amplification.

How to set Relative and Offset Power Measurements

- Press **Scale / Amptd**.
- Then choose from the following:
 - **Relative On Off** When switched to ON, the FieldFox measures and stores the current power level. Subsequent power measurements display a power level which is relative to the stored value. When relative is ON, the units change from dBm to dB or from Watts to %.
 - **Offset On Off** Toggles ON and OFF the displayed power level using the Offset value.
 - **Offset Val** Value by which the power meter display is offset. A positive value compensates for a component with loss. A negative value compensates for a component with gain. Offset values are limited to +/- 100 dB.

Display Units

Sets the Power Meter display to dBm or Watts. When making relative power measurements, these change to dB and %.

How to set Power Meter display units

- Press **Meas Setup 4** or **Scale / Amptd**.
- Then **Unit**.
- Then choose from the following:
 - **dBm (dB)** Sets Power Meter display to dBm or dB.
 - **Watt (%)** Sets Power Meter display to Watts or %.

Resolution

Sets the number of digits to display after the decimal point on the digital power meter display.

How to set Resolution

- Press **Scale / Amptd**.
- Then **More**.
- Then choose from 0, 1, 2, or 3.

Averaging

Power Meter Averaging is used to improve measurement accuracy in low power or noisy power situations. Increased averaging improves measurement accuracy, but also reduces measurement speed.

How to set Power Meter Averaging

- Press **BW 2** or **Meas Setup 4**.
- Then choose from the following:
 - **Averaging Auto Man Off**
 - **Auto** Allows the USB Power Sensor to use its Auto Averaging settings. See the USB Power Sensor documentation for details.

- **Man** Manually enter an averaging count by setting **Num Averages**.
- **OFF** Performs NO averaging.
- **Num Averages** Sets the number of Power Meter readings to be averaged before a valid reading is displayed. When a number is entered, **Averaging** is automatically set to Man.

Single or Continuous Measure

This setting determines whether the FieldFox measures continuously or only once each time the **Single** button is pressed. Use **Single** to conserve battery power or to allow you to save or analyze a specific measurement.

This setting can be changed at any time without affecting calibration accuracy.

How to set Single or Continuous

- Press **Sweep 3**.
- Then choose one of the following:
 - **Single** Automatically sets Continuous OFF and causes FieldFox to make ONE measurement, then hold for the next Single key press. When a data trace is displayed, the entire trace is measured, then holds. The **Hold** annotation changes to an arrow --> while the measurement occurs.
 - **Continuous** Makes continuous measurements. This is the typical setting when battery power is not critical.

You can also use **Run / Hold +/-** to toggle between Single and Continuous.

Step Detection Mode

The FieldFox supports the Step Detection feature that is present in U2000 series power meters. When enabled, this feature reduces settling time after a significant step in the measured power. For more information, please refer to the USB Power Meter documentation.

How to set Step Detection mode

- Press **Meas Setup 4**.
- Then **Step Detection ON Off**
- Then choose from the following:
 - **ON** Enables step detection (default setting)
 - **OFF** Disables step detection

Limits

In Power Meter Mode, Minimum and Maximum limits set a visible range of acceptable readings between these two values. Readings that are below the minimum or above the maximum are clearly visible on the power meter display.

How to set Limits

- Press **Limit 8**.
- Then choose from the following:
 - **Min Limit On Off** Toggles the display of the Minimum limit ON and OFF.

- **Min Limit Value** Sets the Minimum limit power value. Power reading lower than this will exceed the limit.
- **Max Limit On Off** Toggles the display of the Maximum limit ON and OFF.
- **Max Limit Value** Sets the Maximum limit power value. Power reading higher than this will exceed the limit.

Frequency Offset using Power Sensor (FOPS) – Option 208

FOPS is accessed through (and requires) Option 302 USB Power Meter Mode. With both options installed, you can send a signal with the FieldFox internal source at one frequency, and measure this signal with an Keysight U-Series USB Power Sensor at another frequency.

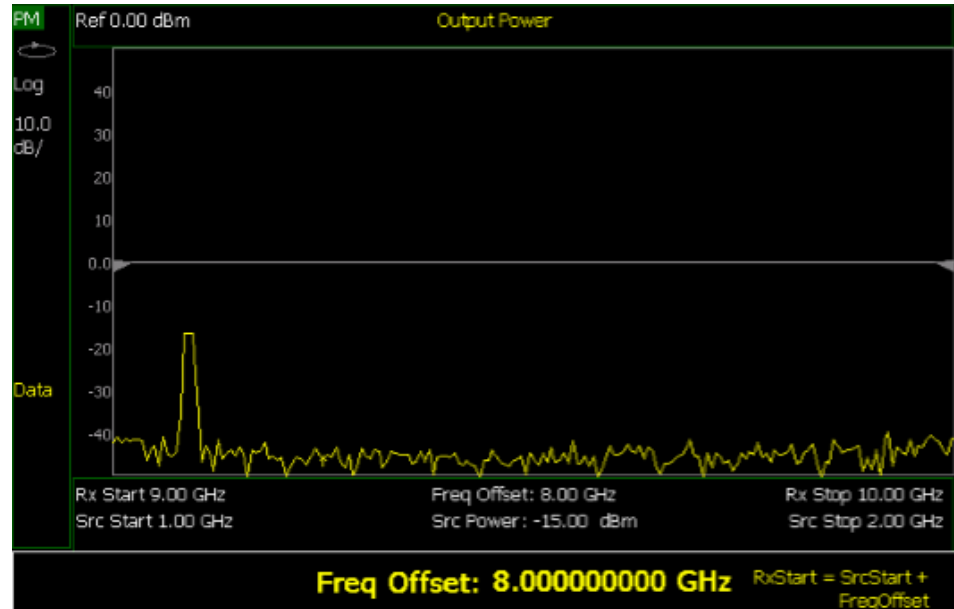

Display for FOPS

In this Chapter

Overview.....	86
Measurement Selection.....	87
Sweep Type and Frequency	87
Power Sensor Settling	89
Sweep Settings	89
Amplitude Markers	90

See Also

Trace Math.....	122
-----------------	-----

Overview

The following shows a typical use case for FOPS:

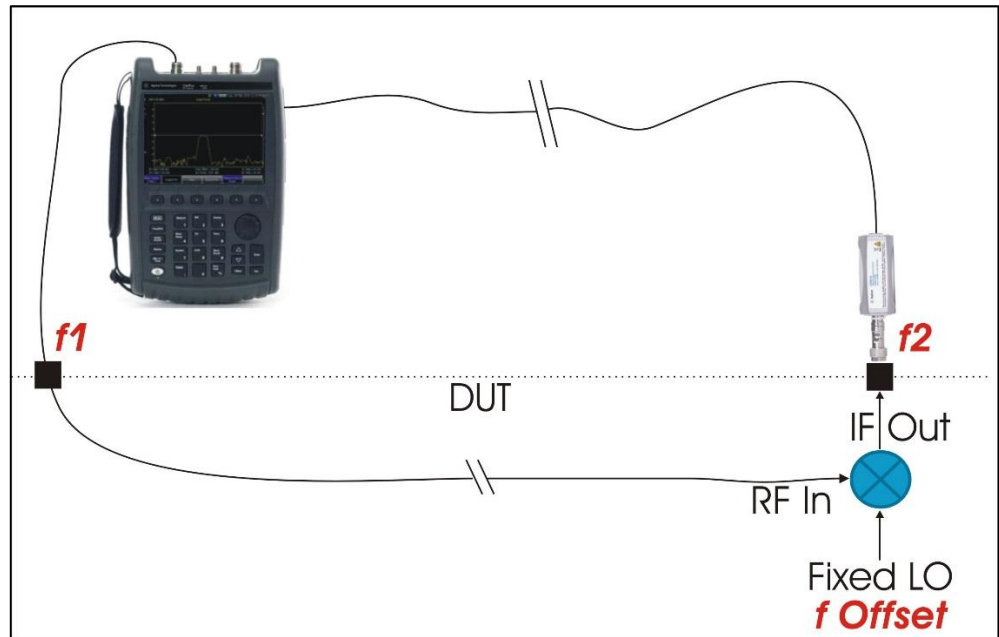

- The DUT is a long section of cable with a mixer and bandpass filter on the IF Output.
- The FieldFox source is tuned to f_1 .
- The USB power sensor, with an equally long USB/LAN cable, is connected to the IF Output. USB/LAN extenders are NOT provided with the FieldFox or Keysight USB power sensors.
- Conversion gain/loss is measured at f_2 , which is $(f_1 \pm f \text{ Offset})$.

NOTE The dynamic range with FOPS may be significantly different when using various power sensors. In general, the lower frequency range sensors have better dynamic range.

FOPS Settings

The following settings are unique to FOPS. Standard USB Power Meter mode settings, which may be useful with FOPS, are documented in that chapter starting on page 78.

Select Power Meter (USB Sensor) before making any setting in this section.

How to select Power Meter (USB Sensor)

- Press **Mode**
- Then **Power Meter (USB Sensor)**
- Then connect a USB Power Sensor to either FieldFox USB port.
- For a complete list of supported Keysight USB Power Sensors, please visit: www.keysight.com/find/usbsensorsforfieldfox

Measurement Selection

- Press **Measure 1**
- Then choose from the following:
- **Src Power Measure** Similar to a 'normalization' cal, this selection guides you through the following steps to make a measurement at the reference plane and then store the data trace into memory.
 1. Connect the power sensor to the measurement reference plane. This is the location to where power measurements are to be referenced. For example, to measure only the conversion loss through a converter, attach the power sensor to the cable that connects to the converter input.
 2. Press **Measure**. When finished, press **Src Data -> Mem** to store the measured data into FieldFox memory. Preset or Mode Preset will clear the stored memory.
 3. Optionally choose from the following:
 - **Re-Measure** Make another measurement
 - **Src Data** View only the re-measured data.
 - **Src Memory** View only the stored memory data.
 - **Src Data & Memory** View both the re-measured data and the stored memory data.
 4. Press **Done**
- **Src Pwr Memory** Not available until source data is stored into memory. Displays only the source power memory trace.
- **Gain** Not available until source data is stored into memory. Displays the Output power / Source power (memory trace).
- **Rx Power** Displays the raw output power at the USB power sensor.

Sweep Type and Frequency

Set the source and receiver frequencies for the FOPS measurements. The receiver is a Keysight U-Series Power Sensor. These are broadband measurement devices, which means that they measure power over a very wide frequency range. Tables of frequency and power correction factors are stored within the power sensors. The receiver (Rx) frequencies are used ONLY to apply the appropriate correction factors to the power levels measured with the power sensor.

NOTE It is YOUR responsibility to ensure that ONLY the signal of interest is present at the power sensor. All other signals MUST be filtered appropriately.

How to set Sweep Type and Frequency

- Press **Freq/Dist**
- Then **Frequency**
- Then **Sweep Type**
- Then choose from the following:
- **CW** Used to make standard (non-offset) power meter measurements at a single frequency. Learn more beginning on page 78.

NOTE To make swept FOPS measurements at a single frequency, choose **Swept**, then enter a Src Center frequency, then Span = 0 Hz.

- **Swept** Used to make swept FOPS measurements.
 - Then enter source (Src) frequencies as either Center and Span or Start and Stop. Both methods set the FieldFox internal source sweep range out the Port 1 RF Output connector.

The frequency limits are determined by the limits of both the FieldFox and the power sensor.

 - The LOW frequency is limited by the higher of either the FieldFox or the power sensor minimum frequencies.
 - The HIGH frequency is limited by the lower of either the FieldFox or the power sensor maximum frequencies.
 - Then **More**.
 - Then **Freq Display**. This determines how the receiver frequencies below the gratitudes are displayed. Choose from the following:
 - **Start** Annotated as Start and Stop frequencies.
 - **Center** Annotated as Center and Span frequencies.
 - Then choose from the following two methods to determine the **offset frequency** (the frequency that the receiver is offset from the source). This is typically the frequency of the LO that is used with the frequency converter. The frequency offset may be positive, negative, or zero.
 - **Freq Offset** Enter an Offset frequency. The receiver frequencies are calculated.
 - **Offset Calculator Calculate Offset** Enter the Receiver Start and Stop frequencies. Then press **Calculate Offset**.
 - Press **Rx Swp** to select the receiver sweep direction.
 - **Fwd** Used for systems for which the output frequency is Offs + Src. The output frequency of the DUT and the receiver sweeps in the same direction as the source.
 - **Rev** Used for systems for which the output frequency is Offs - Src. The output frequency of the DUT and the receiver sweeps in reverse direction as compared to the source.

Invalid Settings

Violations of the following conditions will return an error message:

- The frequency span for the source and receiver must be the same.
- Both the source and receiver frequencies must be positive.

FOPS Configuration Examples

Negative Offset, RxSwp = Fwd (Offs + Src)

Src = 2 GHz to 3 GHz

Offset = -1 GHz

Rx = 1 GHz to 2 GHz

Positive Offset, RxSwp = **Rev** (Offs - Src)

Src = 2 GHz to 3 GHz

Offset = 3.8 GHz

Rx = 1.800 GHz to 800 MHz

Positive Offset, RxSwp = **Fwd** (Offs + Src)

Src = 2 GHz to 3 GHz

Offset = 3.8 GHz

Rx = 5.8 GHz to 6.8 GHz

Power Sensor Settling

The following two settings work together to allow you to choose the right compromise between measurement speed and accuracy.

Each power sensor reading is considered "settled" when **either**:

- The difference between two consecutive readings are within the Tolerance value – **or when**:
- The Max (number of) Readings has been made.

The readings that were taken are averaged together to become the displayed reading.

How to choose Power Sensor settling

- Press **BW 2**
- Then **Tolerance**. Enter a value in dB between 0 and 10 using the numeric keypad, the **▲▼** arrows, or the rotary knob. Tolerance of 0 will never be achieved, so the Max Readings will always be made. Press **Enter**
- Then **Max Readings**. Enter a value between 1 and 20 using the numeric keypad, the **▲▼** arrows, or the rotary knob. Press **Enter**

Sweep Settings

These settings provide added control of the FOPS measurement.

How to make additional sweep settings

- Press **Sweep 3**
- Then choose from the following:
 - **Power Setup**
 - **Source Enable**
 - **ON** Turn ON the internal source (required for FOPS).
 - **OFF** Turn OFF the internal source
 - **Src Nom Power** (-15 dBm default setting) Set output power to an arbitrary value at the source CW frequency. Then enter a value using the numeric keypad, the **▲▼** arrows, or the rotary knob. Press **Enter**

- **Num Points** or **Freq Step Size** Both settings control the number of power sensor measurements between the Start and Stop frequencies. Enter one setting and the other will be changed automatically. There must be at least two data points.
- **Dwell /Point** Specifies a settling time (in seconds) after the internal source steps to the next frequency and before the power sensor makes a measurement.

Amplitude Markers

Amplitude markers are horizontal dotted lines that you can move to any amplitude level on the screen. The two amplitude markers can be set independently or used as a pair of delta markers.

Amplitude markers can be used as a visual comparison aid with the data trace.

How to make Amplitude Marker settings

- Press **Marker**
- Then **More**
- Then **Ampl Markers**
- Then choose from the following:
 - **OFF** Amplitude markers are NOT displayed.
 - **ON** Amplitude markers ARE displayed at their previous positions.
- Then **Ampl Mkr 1 or 2**
- Enter a value in dBm for the marker using the numeric keypad, the **▲▼** arrows, or the rotary knob.
- Press **Delta AmplMkr**
- Then choose from the following:
 - **ON** AmplMkr 2 value is relative to AmplMkr 1. When AmplMkr 1 is moved, AmplMkr 2 also moves to maintain the AmplMkr 2 value between them.
 - **OFF** The two amplitude markers move independent of one another.

Trace Math

Trace Math allows you to compare data traces and perform simple math. Learn how to use Trace Math beginning on page 122. All Data and Memory features work as documented EXCEPT for the following:

NOTE When Trace, then Data -> Mem is pressed, if a **Src Power** trace is active, then RxPower is actually stored into memory.

To Compare Src Power (Input) and Rx Power (Output):

1. Meas Rx Power
2. Store to memory
3. View Data & Memory
4. Meas Src Power.

Pulse Measurements Mode - Option 330

Pulsed power meter measurements, available with Option 330, are made with Keysight U2020 X-Series USB Peak Power Sensors. These sensors are capable of detecting, measuring, and storing data from a train of pulses at the RF input. This data is queried from the USB Power Sensor and displayed on the FieldFox screen. You can then analyze the data using several selectable settings.

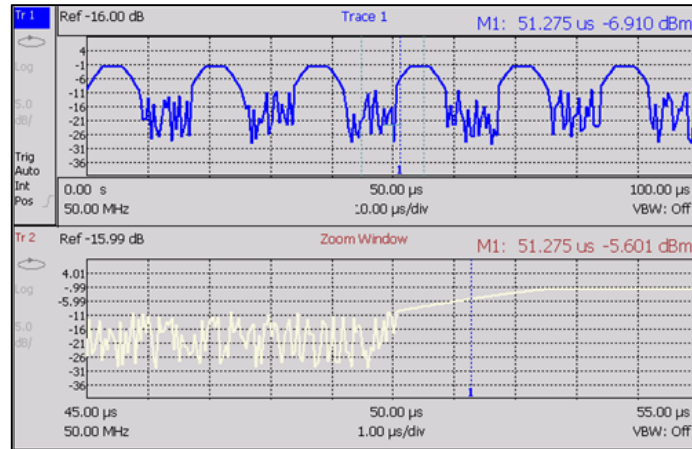

In this Chapter

Supported Power Sensors	92
Measurement Selection	92
Frequency / Time	93
Zoom Window	93
Scale	94
Averaging	94
Video Bandwidth	95
Single or Continuous Measure	95
Resolution	96
Triggering	96
Pulse Timing Diagram	98
Marker Settings	98
Amplitude Markers	98
Marker Search	99
Auto Analysis	99
Pulse Top	100
Grid	100
Trace Memory	101

NOTE Many of the features included with the FieldFox Pulse Measurements Mode are discussed in detail in these two documents:

- Keysight U2020 X-Series USB Peak Power Sensors Programmer's Guide.
<http://literature.cdn.keysight.com/litweb/pdf/U2021-90003.pdf>

- “Best Practices For Making The Most Accurate Radar Pulse Measurements”
<http://literature.cdn.keysight.com/litweb/pdf/5991-0434EN.pdf>

Supported Power Sensors

Pulse measurements are made using any of the Keysight U2020 X-Series USB Peak Power Sensors.

Zeroing of the U2020 X-Series USB Peak Power Sensors is performed automatically at power up, every 5 seconds, and prior to measuring low level signals.

Switching between Pulse Measurement Mode and Power Meter Mode

NOT Supported - Using a single USB Peak Power Sensor and switching between Power Meter Mode and Pulse Measurement Mode. Both modes will attempt to program the sensor, which could cause one or both modes to hang, or at least report inaccurate data.

Supported - Using one U2000A Average Power Sensor connected to the top USB port for Power Meter Mode, and one Peak Power Sensor connected to the bottom USB port for Pulse Measurement Mode.

How to Connect the Power Sensor

Connect your Power Sensor to one of the FieldFox USB ports.

NOTE Use an attenuator between the DUT and the power sensor when measuring power levels that are higher than +20 dBm. The attenuator value can be subtracted from the measurement using the Offset feature, discussed on page 81.

A sequence of status lights are displayed on the base of the power sensor.

- **Green blinking** light indicates the power sensor is communicating or self-tests are being performed. Because the FieldFox is usually communicating with the power sensor when it is connected, this is the normal mode of operation.
- **Amber light** indicates Zeroing is being performed.
- **Red light** indicates an error has occurred with the power sensor. Refer to power sensor documentation.
- **No light** indicates the FieldFox is not communicating with the power sensor. This is the case when in Hold mode or when NOT in Pulsed Measurement Mode.

Pulse Measurement Settings

Select Pulse Measurement Mode before making any setting in this section.

How to select Pulse Measurement Mode

- Press **Mode**
- Then **More** if your FieldFox contains more than five measurement modes.
- Then **Pulse Measurement**

Measurement Selection

The pulse measurement results are presented as either a traditional power meter display or as a trace graph.

How to select the Measurement

- Press **Measure 1**

- Then choose from the following:
 - **Average** Average power (Meter display)
 - **Peak** Peak power (Meter display)
 - **Pk to Avg** Displays the difference between the above two measurements (Meter display)
 - **Trace Graph** (default) The primary trace (**Tr 1**) plots pulse data in amplitude versus time. Optionally, you can enable a secondary 'zoom' trace. Learn how on page 93.

When a 'Meter display' measurement is selected, the following Pulse Measurement Mode settings are identical to the standard USB Power Meter Mode settings.

- Learn how to set **Scale** on page 81.
- Learn how to set **Relative and Offset Power** on page 81.
- Learn how to set **Display Units** on page 82.
- Learn how to set **Limits** on page 83.

Frequency / Time

How to set Frequency

- Press **Freq/Dist**
- Then choose from the following:
 - **Frequency** Sets the center frequency of the carrier on which pulse modulation resides. This is used to set amplitude correction of the USB Power Sensor.

How to set Time

Specify the time over which data will be acquired by the USB Power Sensor. When Trace Graph is selected, **Tr 1** is annotated with these values. Time can be specified using either of the following pairs of values:

- **Center 1** and **Time/div 1** Specify the center time and time per division.
 - **Start Time** and **Time Length** Specify the start time and length of acquisition.
 - A positive start time indicates a delay after the sensor detects a pulse signal.
 - A negative start time displays data that is acquired BEFORE the sensor detects a pulse signal (or T-zero).
- Follow each by entering a value using the numeric keypad, the **▲▼** arrows, or the rotary knob.
 - After using the keypad, select a multiplier key. Learn about multiplier abbreviations on page 19.

Zoom Window

When Trace Graph is selected as the measurement, a secondary Zoom Trace can be used to view a zoomed portion of **Tr 1**. When Zoom Window is ON, blue vertical posts appear on **Tr 1** to indicate the current start, center, and stop times of the zoom window. The zoom window can be scaled using the standard Scale settings.

How to make Zoom Window settings

- Press **Trace 6**
- Then **Zoom Window**
- Then choose from the following:
 - **ON** Opens the zoom window on the bottom half of the FieldFox screen. The window includes the zoomed trace.
 - **OFF** Closes the zoom window.
- **Zoom Center** While monitoring the **T** within the blue vertical posts on Tr 1, enter a value for the center time using the numeric keypad, the **▲▼** arrows, or the rotary knob.
- **Zoom Time/div** While monitoring the blue vertical posts on the primary trace, enter a value for the zoom window span using the numeric keypad, the **▲▼** arrows, or the rotary knob.
- **Trace 1** Press to select **Tr 1**. This can also be done by using the **▲▼** arrows. Select a trace before making trace settings, such as Scale.
- **Zoom Trace** Press to select the zoom trace.

Scale

For Meter-style measurements, learn how to set Scale, Relative and Offset Power, display Units, and Resolution beginning on page 81.

How to set Scale for Trace Graph measurements

- Select a trace to scale using the **▲▼** arrows.
- Press **Scale / Amptd**
- Then choose from the following methods:
 - **Autoscale** Automatically adjusts the Y-axis to comfortably fit the Min and Max amplitude of the trace on the screen.
- Set Scale, Reference Level, and Reference Position:
 - **Scale** Manually enter a **scale per division** to view specific areas of the trace.
 - **Ref Level** Manually set the value of the reference line. Enter a negative value by pressing **Run/Hold (+/-)** either before or after typing a value.
 - **Ref Position** Manually set the position of the reference line. Values must be between **0** (TOP line) and **10** (BOTTOM line).
 - **Offset ON** Enable Offset. When only trace 1 is visible, **Offset ON** appears to the left of the trace.
 - **Offset Val** Enter a value by which all amplitude values will be offset. This can have the effect of virtually removing a component from the measurement path. A positive value compensates for a component with loss. A negative value compensates for a component with gain. Offset values are limited to +/- 100 dB.

Averaging

Averaging helps to reduce the effects of random noise on a measurement. The more measurements that are averaged, the greater the amount of noise reduction. Averaging is allowed for all pulse measurements.

Averaging is performed in the USB Power Sensor before the data is sent to the FieldFox.

Annotation in the left pane shows the state of the Average setting. When Manual is selected, the 'Num of Averages' setting is also shown.

How to set Averaging

- Press **BW 2**.
- Then **Averaging**
- Then choose from the following:
 - **Auto** Averaging is set to a reasonable value by the USB Power Sensor.
 - **Man** Averaging is set to the value specified in the 'Num Averages' setting.
 - **Off** Averaging is OFF
- **Num Averages** Select a value using the numeric keypad, then press **Enter**.

Video Bandwidth

The Video Bandwidth setting enables an FIR (finite impulse response) filter within the USB Power Sensor. The filter setting affects the appearance of the trace results.

Video Bandwidth is allowed for all pulse measurements

How to set Video Bandwidth

- Press **BW 2**.
- Then **Video Bandwidth**
- Then choose from the following:
 - **Off** Video Bandwidth is disabled.
 - **Low** Similar to a low pass filter, ripple in the pass band is minimized but allows higher side-lobes on the filter skirt.
 - **Medium** Smooth pass band with reasonable transition ripple.
 - **High** The pass band ripple is similar to the OFF setting, but the transition skirts are smoother.

Single or Continuous Measure

This setting determines whether the FieldFox continuously queries the USB Power Sensor for data, or only once each time the **Single** button is pressed. Use **Single** to conserve battery power or to allow you to save or analyze specific data.

How to set Single or Continuous

- Press **Sweep 3**
- Then choose one of the following:

- **Single** Automatically sets Continuous OFF and causes the FieldFox to query the USB Power Sensor ONCE, then hold for the next **Single** key press. **Hold** is annotated in the upper left corner of the display.
- **Continuous** Queries the USB Power Sensor whenever a valid trigger signal is present. This is the typical setting when battery power is not critical.

You can also use **Run / Hold +/-** to toggle between Single and Continuous.

Resolution

Resolution is the number of individual acquisitions that occur in the USB Power Sensor. This data is read by the FieldFox and plotted across the X-axis to form a trace. More data points increases measurement resolution. However, more data points requires more time to acquire, query, and plot.

How to set Resolution

- Press **Sweep 3**
- Then **Resolution**
- Then choose from the following:
 - **Low** 240 data points.
 - **Medium** 1000 data points.
 - **High** Calculated value - approximately 8000 data points.

Triggering

For pulse measurements, a trigger signal refers to the event that causes the USB Peak Power Sensor to initiate measurement acquisition. It does NOT refer to triggering the FieldFox.

Trigger settings can be used with ALL pulse measurements unless stated otherwise.

A **Waiting for Trigger** message on the FieldFox screen is posted on behalf of the USB Power Sensor when it is waiting for a pulse signal at the RF Input (Internal) or a TTL signal at the USB Sensor External Trigger input.

How to make Trigger settings

- Press **Sweep 3**
- Then **Trigger**
- Then **Trig Type**
- Then choose from the following:
 - **Freerun** The USB Power Sensor acquires data without waiting for a trigger. This mode is NOT supported for Trace Graph measurements.
 - **Internal** The USB Power Sensor acquires data when a valid pulse signal is detected at the RF input. The following Trigger settings determine the validity of the trigger signal.
 - **External** The USB Power Sensor acquires data when a valid TTL signal is detected at the USB Power Sensor external trigger input.

Trigger Edge

This setting determines which edge of a trigger signal initiates data acquisition.

- Press **Sweep 3**
- Then **Trigger**
- Then **Trig Edge**
- Then choose from the following:
 - **Pos** Acquisition is triggered by the rising (positive) edge of a valid signal.
 - **Neg** Acquisition is triggered by the falling (negative) edge of a valid signal.

Trigger Delay

After a valid trigger signal is received at the USB Power Sensor, data acquisition begins after the specified Trigger Delay time **PLUS** the specified Start time. See the Pulse Timing diagram on page 98 for more information.

- Press **Sweep 3**
- Then **Trigger**
- Then **Trig Delay**
- Then enter a value using the numeric keypad, the **▲▼** arrows, or the rotary knob.

Auto Trigger

Used **ONLY** when Trigger Type = Internal, this setting determines whether the trigger level is set manually or is set to the default level in the USB Power Sensor firmware.

- Press **Sweep 3**
- Then **Trigger**
- Then **AutoTrig**
- Then choose from the following:
 - **ON** Trigger level is determined by the USB Power Sensor firmware.
 - **OFF** The trigger level is set manually using the Trigger Level setting.

Trigger Level

Used when Trigger Type = Internal AND Auto Trigger = OFF (Manual).

- Press **Sweep 3**
- Then **Trigger**
- Then **Trig Level**
- Then set the trigger level using the numeric keypad, the **▲▼** arrows, or the rotary knob. A line appears on **Tr 1** at the current trigger level setting. Data acquisition occurs when the RF input signal crosses the line. This setting can be used with either Positive or Negative edge triggering.

Trigger Settings Annotation

Trigger settings are annotated on the FieldFox screen as highlighted in **red** in the following image:



- Trig Level = -10 dBm, Trig Type (Int), Pos Slope (/), Delay

Pulse Timing Diagram

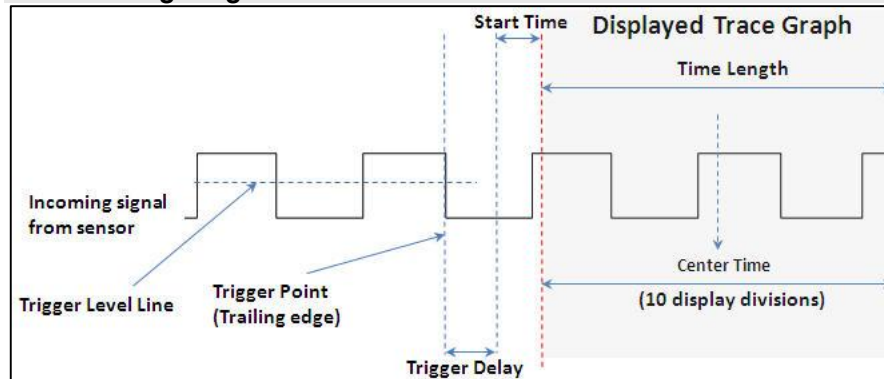

Marker Settings

Markers are not allowed with Meter-style measurements.

Markers are displayed on **Tr 1** and also on the zoom trace if the marker is within the zoom window time span.

Up to six standard markers can be used to provide readouts of the Y-axis amplitude at the current X-axis location.

The six standard markers can also be used as Delta Markers.

Learn more about standard markers on page 110.

Amplitude Markers

Amplitude markers are horizontal dotted lines that you can move to any amplitude level on the screen. The two amplitude markers can be set independently or used as a pair of delta markers.

Amplitude markers can be used as a visually comparison aid with the pulse measurement traces.

How to make Amplitude Marker settings

- Press **Marker**
- Then **More**
- Then **Ampl Markers**

- Then choose from the following:
 - **OFF** Amplitude markers are NOT displayed.
 - **ON** Amplitude markers ARE displayed at their previous positions.
- Then **Ampl Mkr 1 or 2**
- Enter a value in dBm for the marker using the numeric keypad, the **▲▼** arrows, or the rotary knob.
- Press **Delta AmplMkr**
- Then choose from the following:
 - **ON** AmplMkr 2 value is relative to AmplMkr 1. When AmplMkr 1 is moved, AmplMkr 2 also moves to maintain the AmplMkr 2 value between them.
 - **OFF** The two amplitude markers move independent of one another.

Marker Search

Use Marker Search to find and move markers to locations on the **Tr 1** trace.

How to Search with Markers

- Activate the marker to be used for the search
- Then press **Mrk ->/Tools**.
- Then **Marker Search**
- Then **Zone Search**
- Then choose from the following:
 - **ON** Available ONLY when the zoom window is enabled, the search is limited to the zone defined by the zoom window.
 - **OFF** The search is performed over the entire **Tr 1** trace.

Then choose from the following:

- **Target**, **Peak**, and **Minimum**. Learn more about these standard features beginning on page 114.
- **Rise Time** Select, then set a value in dB. Delta markers are created and placed at the Peak and at the specified value BEFORE the Peak.
- **Fall Time** Select, then set a value in dB. Delta markers are created and placed at the Peak and at the specified value AFTER the Peak.

NOTE Rise and Fall time in Marker Search uses different criteria than in Auto Analysis and will therefore result in different reported values.

Auto Analysis

Auto Analysis reports the following TEN pulse measurements:

Avg:	1	-22.48 dBm	5	172.29 ns		
Peak:	2	-14.97 dBm	6	85.01 ns		
Pk-Avg:	3	7.51 dB	7	9.04 μs	9	11.90 %
Pulse Top:	4	-15.01 dBm	8	76.00 μs	10	13.16 kHz

-
- 1 - Average Power Average power level of all measured data points
 - 2 - Peak Power Highest reading of all measured data points
-

3 - Peak minus Average	Difference between the above two results
4 - Pulse Top	Power value based on the specified Pulse Top setting.
5 - Rise Time	The time it takes for a pulse to rise from 10% to 90% of its peak value.
6 - Fall Time	The time it takes for a pulse to fall from 90% to 10% of its peak value.
7 - Pulse Width	The time between the rising edge and falling edge of a pulse.
8 - Pulse Period	The time of one complete pulse cycle
9 - Duty Cycle	The ratio of the pulse duration to the pulse period.
10 - Pulse Rep Freq	The rate, in pulses / sec, at which pulses recur.

How to enable Auto Analysis

- Press **Mrk ->/Tools**.
- Then **Auto Analysis**
- Then choose from the following:
 - **OFF** Analysis OFF
 - **ON** The Analysis values appear below trace 1.

Pulse Top

Pulse Top is NOT the same as the pulse Peak. Pulse Top is used to set and report the reference power level. You enter a value in percent, and the Pulse Top value is reported in the Auto Analysis table in dB down from 100% of the reference power level.

How to set Pulse Top

- Press **Mrk ->/Tools**
- Then **Pulse Top**
- Then enter a percent value between 0 and 100 using the numeric keypad, the **▲▼** arrows, or the rotary knob.
 - When set to 10%, 10 dB down from the 100% reference level is reported.
 - When set to 50%, 3 dB down from the 100% reference level is reported.
 - When set to 90%, 0.5 dB down from the 100% reference level is reported.

Grid

Enables and disables the display of a 10 x 10 grid on the FieldFox screen.

How to enable Grid display

- Press **Mrk ->/Tools**
- Then **Grid**
 - OFF** Grid OFF
 - ON** A grid of X/Y lines appears on the screen.

Trace Memory

A memory trace is a pulse measurement **Tr 1** data trace (NOT the trace in the Zoom window) that has been stored in the FieldFox volatile memory. It then becomes static, meaning it is not updated with normal pulse measurements. It can be displayed on the screen by itself, or with a pulse trace for comparison purposes.

- The **Tr 1** trace is displayed in yellow.
- The memory trace is displayed in blue.

How to display data and memory traces

- Press **Trace 6**.
 - Then **Trace Memory**
 - Then **Data->Mem** to store the current live trace into memory. A 'beep' sounds to confirm the data trace has been saved to memory. There is no display annotation that indicates that the memory trace has been stored.
 - Press **Data** to view only the data trace.
 - Press **Memory** to view only the memory trace.
- Press **Data & Memory** to view both the live trace and the stored memory trace.

VVM (Vector Voltmeter) Mode

VVM Mode (Option 308) measures the electrical length of cables and other devices. The 1-Port Cable Trimming and 2-Port Transmission measurement displays the electrical length in both Magnitude and Phase.

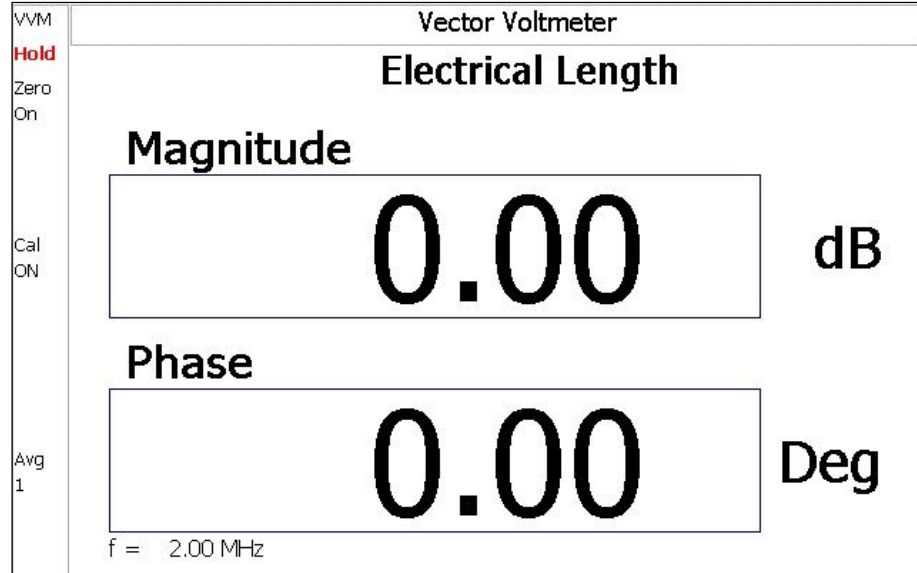

Display for the 1-Port Cable Trimming measurement

In this Chapter

Overview.....	103
VVM Calibration.....	106
Measurement Selection.....	103
Frequency Selection.....	104
Display Resolution.....	104
IF Bandwidth.....	104
Output Power.....	104
Averaging.....	104
Single/Continuous.....	105
Zeroing.....	106

Procedures

1-Port Cable Trimming Measurement.....	107
2-Port Transmission Measurement.....	108
A/B and B/A Measurement.....	108

Overview

In the FieldFox, both 1-port and 2-port measurement types use a different configuration setup from the HP/Keysight 8508A Vector Voltmeter.

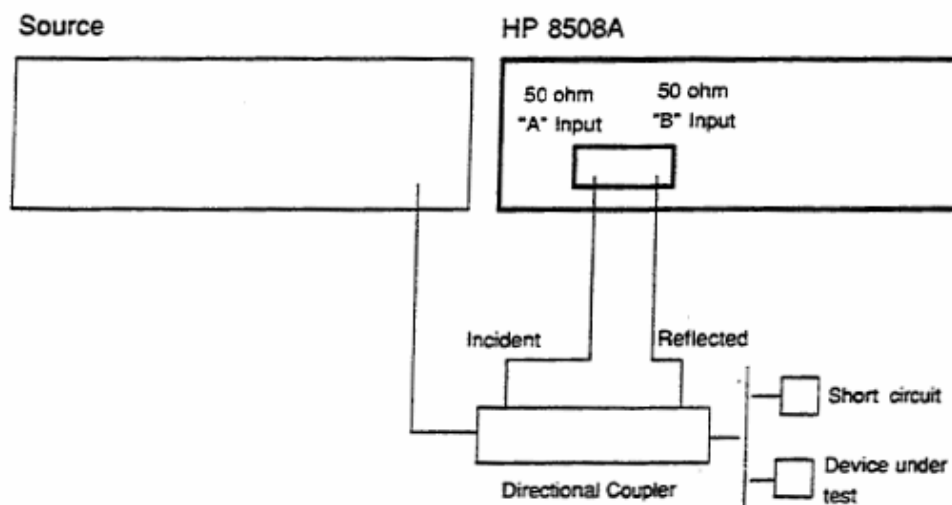

Typical 8508A measurement configuration –as shown in the 8508A manual.

The above block diagram requires an external source and directional coupler to measure the electrical length of a DUT or cable to be trimmed. Separate paths are used to measure the Incident signal (A) and Reflected signal (B). To measure the ratio of the Reflected/Incident signals, you were required to select B/A for both the Magnitude and Phase display.

In the FieldFox, the source and directional coupler are inside the instrument. This allows you to connect the DUT to ONLY the FieldFox Port 1, with NO external instruments, in order to make Cable Trimming measurements.

See the FieldFox block diagram and Cable Trimming procedures beginning on page 107.

VVM Mode Settings

Select VVM Mode before making any setting in this section.

How to select VVM Mode

- Press **Mode**
- Then **VVM**

Measurement Selection

How to select a VVM Measurement

- Press **Measure 1**
- Then choose from the following:
 - **1-Port Cable Trimming** 1-port reflection measurement. Learn how to make this measurement on page 107.
 - **2-Port Transmission** 2-port transmission measurement. Learn how to make this measurement on page 108.

- **B/A** and **A/B** 2-port ratioed receiver measurements using external sources. Learn more on page 108.

Frequency Selection

VVM measurements are made at a single CW frequency.

How to set Frequency

NOTE Frequency can be set to 1 Hz resolution.

- Press **Freq/Dist**
- Then **Frequency**
- Enter a value using the numeric keypad, the **▲|▼** arrows, or the rotary knob.
- After using the **▲|▼** arrows or the rotary knob, press **Enter**. The increment setting of the arrows is based on the current span and can NOT be changed in VVM Mode.
- After using the keypad, select a multiplier key. Learn about multiplier abbreviations on page 19.

Display Resolution

You can display either one digit or two digits after the decimal point for both magnitude and phase readings.

This setting survives a Preset and Mode Preset.

How to set Resolution

- Press **Scale/Amptd**
- Then **Resolution**
- Then choose:
 - **1** 0.0 (default)
 - **2** 0.00

IF Bandwidth

Reducing the IF receiver bandwidth reduces the effect of random noise on a measurement. However, narrower IF bandwidths cause longer measurement times.

For highest accuracy, perform calibration and Zero AFTER changing the IF Bandwidth. Learn about Zeroing on page 106.

How to set IF BW

- Press **BW 2**
- Then **IF BW**
- Then choose from the following: **300 Hz | 1 kHz | 3 kHz | 10 kHz | 30 kHz**

Output Power

Set the power level out of the FieldFox to High, Low, or manually set power level to a value between High and Low.

Generally, the high power setting is used when measuring passive, high-loss devices to place the signal farther from the noise floor. However, for devices that are sensitive to high power levels such as amplifiers, use the Low power setting.

For best measurement accuracy, use the **Manual** power setting at -15 dBm. After calibration, the power level can be decreased for amplifiers, or increased for higher dynamic range.

Caution Power Level settings in this mode will NOT change Power Level settings in other modes. To help prevent damage to your DUT, use caution when changing modes with your DUT connected to the FieldFox test ports.

How to set Output Power

- Press **Meas Setup 4** then **More**
- Then **Output Power**
 - **High** (Default setting) Sets output power to the maximum achievable power at the displayed frequency. Please see the FieldFox Specifications for expected power levels.
 - **Low** Sets output power to approximately -42 dBm.
 - **Man** Set output power to an arbitrary value.
 - Then press **Nominal Power**
 - Then enter a value using the numeric keypad, the **▲▼** arrows, or the rotary knob.
 - Press **Enter**.

Averaging

Averaging helps to reduce the effects of random noise on a measurement. The FieldFox computes the displayed value over several consecutive readings. Average count determines the number of readings to average. The higher the average count, the greater the amount of noise reduction.

An average counter is shown in the left edge of the screen as **Avg N**. This shows the number of previous readings that have been averaged together. When the counter reaches the specified count, then a 'running average' of the last **N** readings is displayed.

Average count = 1 means there is NO averaging.

This setting can be changed at any time without affecting calibration accuracy.

How to set Averaging

- Press **Meas Setup 4**
- Then **More**
- Then **Average N** where **N** is the current count setting.
- Enter a value using the numeric keypad. Enter 1 for NO averaging.
- Press **Enter**.

To restart the averaging process, press **Meas Setup 4**, then **More**, then **Restart**

Single or Continuous Measure

This setting determines whether the FieldFox measures continuously or only once each time the **Single** button is pressed. Use **Single** to conserve battery power or to allow you to save or analyze a specific measurement.

This setting can be changed at any time without affecting calibration accuracy.

How to set Single or Continuous

- Press **Meas 4**
- Then choose one of the following:
 - **Single** Automatically sets Continuous OFF and causes the FieldFox to make ONE measurement, then hold for the next **Single** key press. When a data trace is displayed, the entire trace is measured, then holds. The **Hold** annotation changes to an arrow --> while the measurement occurs.
 - **Continuous** Makes continuous measurements. This is the typical setting when battery power is not critical.
- You can also use **Run / Hold +/-** to toggle between Single and Continuous.

VVM Calibration

Calibration of a VVM Mode measurement can be accomplished using one of several methods depending on the desired level of accuracy.

- The simplest method is to use CalReady which is accurate at the test port connectors. CalReady does not correct for the loss or delay of jumper cables or adapters that may be used to connect the DUT to the FieldFox. Learn more about CalReady on page 63.
- The next simplest method is to perform a Zeroing.
- When using jumper cables or adapters to connect the DUT to the FieldFox, the most accurate method is to perform a QuickCal or Mechanical Cal. Learn more on page 62. Press **Zero OFF** before calibrating.

Zeroing

Zeroing, also known as Normalization, or Data/Memory, simply “Zeroes” the Magnitude and Phase display when **Zero** is pressed. All subsequent measurements are relative to the measurement that was made when Zero was pressed.

- When performing a 1-Port Cable Trimming operation, a reference cable is connected and measured. Then Zero is pressed, and subsequent cables are measured and trimmed to match electrical length of the reference cable.
- For 2-port measurements, Zero is typically pressed when a THRU connection is made in place of a DUT. Learn more on page 108.

Press **Zero OFF** before performing a QuickCal or Mechanical Cal.

How to select Zeroing

- Press **Meas Setup 4**
- Then **Zero Ref**
 - **Open** – select to display Phase = 0.0 Deg when zeroed.
 - **Short** - select to display Phase = 180.0 Deg when zeroed.
- Then **Zero ON**
- Select **Zero OFF** to turn zeroing off.

1-Port Cable Trimming Measurements

A 1-Port Cable Trimming measurement is used in a cable fabrication procedure to validate proper electrical length.

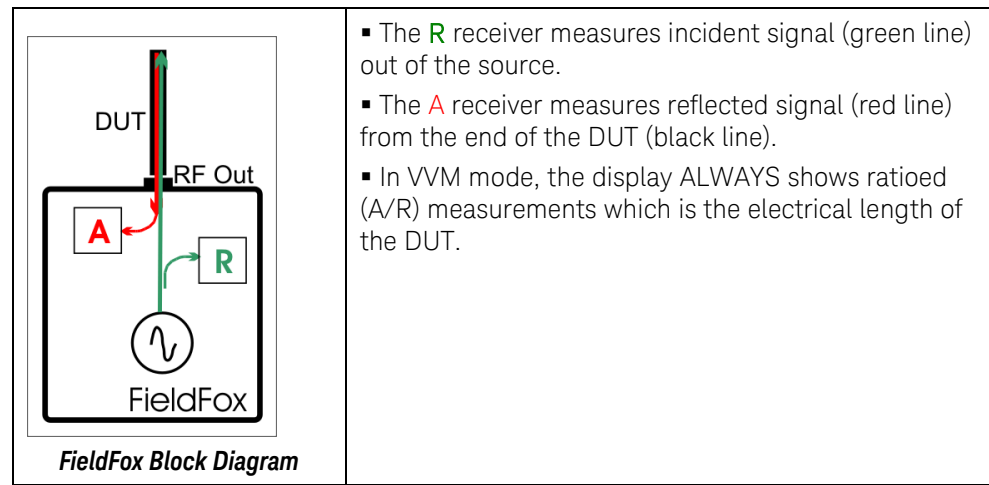

How to make a 1-Port Cable Trimming Measurement

1. Press **Mode** then **VVM** then **1-Port Cable Trimming**.
2. Press **Freq/Dist** and enter the frequency for the measurement.
3. Press **Meas Setup 4** then **Zero OFF**.
4. Calibrate the FieldFox: (Learn more about VVM calibration on page 106.)
 - If using an adapter to connect the cables to the FieldFox, press **Cal 5** then select either **QuickCa** or **Mechanical Ca**. Follow the FieldFox calibration prompts. During calibration, the measurement (S-parameter) is referred to as S11.
 - If connecting the cables directly to the FieldFox test port, CalReady is very accurate.
5. To ensure that the FieldFox is properly calibrated, perform the following **optional Measurement Verification** procedure.

NOTE This measurement verification procedure is suitable for low frequency measurements. However, for high frequency measurements, a more sophisticated procedure is required.

- a. Connect a short standard to the **PORT 1** calibration plane (the location where the calibration was performed).
 - b. Press **Meas Setup 4** and press **Zero**.
 - c. Connect the open standard to the FieldFox **PORT 1** connector.
 - d. Confirm that magnitude measurement is less than -0.1 dB and that the phase value reads 180 degrees.
6. Attach the shortest cable to the FieldFox **PORT 1** connector. This cable is the reference cable. Leave the end of the reference cable open (unterminated).
 7. Press **Meas Setup 4** then press **Zero**.
 8. Remove the reference cable from the FieldFox **PORT 1** connector.
 9. Connect an unterminated, longer cable to the FieldFox **PORT 1** connector.
 10. Observe the displayed phase difference between the reference cable and the attached cable.

11. Carefully trim the cable until the phase shift reads zero. **The attached cable's electrical length is now matched to the reference cable.**
12. Repeat steps 9 through 11 for the remaining cables to be trimmed.

2-Port Transmission Measurements

A 2-Port Transmission measurement is used for measuring electrical length, insertion loss, gain, or isolation of a DUT at a single CW frequency. The FieldFox signal source is transmitted out the port 1 connector, through the DUT, and into the port 2 connector. In the following image, the gain of an amplifier is being measured.

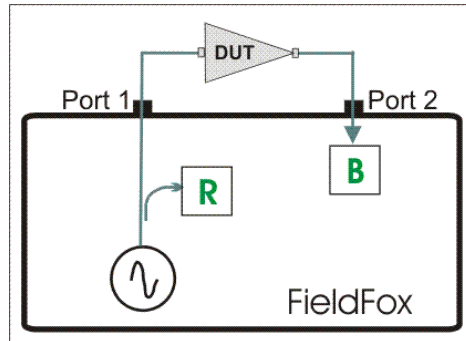

2-Port Transmission measurement of an amplifier

How to make a 2-Port Transmission Measurement

1. Press **Mode** then **VVM** then **2-Port Transmission**.
2. Press **Freq/Dist** and enter the measurement frequency.
3. Calibrate the FieldFox using one of the methods described on page 106. Before performing a QuickCal or Mechanical Cal, press **Meas Setup 4** then **Zero OFF**.
4. Connect the DUT.

Notes:

- The magnitude value is the gain (positive value) or the loss (negative value) of the DUT.
- The phase value is the difference in phase (in degrees) between the DUT input and output.
- To measure isolation of the amplifier, reverse the connection to the amplifier (PORT 1 to the amplifier output).

A/B and B/A Measurements

These measurements allow you to use the FieldFox A and B receivers, along with an external source, to make ratioed measurements.

NOTE These measurements require the “Full 2-port S-parameters” option.

The image below shows a typical configuration for a **B/A** magnitude and phase measurement of a 2-port DUT. This DUT can be an antenna / probe setup. Using network analyzer terms, the image shows the A receiver as the reference receiver which measures the signal that is applied to the DUT. The B receiver is the test port receiver which measures the DUT response.

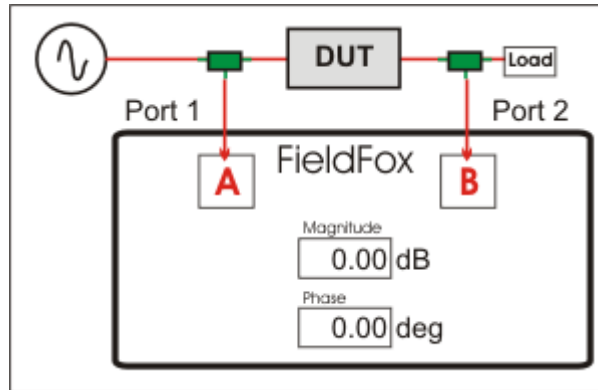

B/A Transmission measurement with external source

Procedure

1. Connect the external source's frequency reference output to the FieldFox **Freq Ref IN** on the top panel. If you are unable to use a common frequency reference, then increase the IFBW to ensure you are measuring the peak of the correct signal. After locating and tuning to the signal, you may be able to lower the IFBW to reduce noise.
2. On the FieldFox, select **System**, then **System Configuration**, then **Frequency Ref**, then **Ext**.
3. Press **Mode**, then **VVM**, then **B/A** or **A/B**.
4. For highest accuracy, set the FieldFox output power to Low. Press **Meas Setup 4**, then **More**, then **Output Power Low**.
5. To calibrate, replace the DUT with a THRU connection, preferably by connecting together the two Power Splitters (shown in green). For low frequency measurements, TEEs can be used.
6. Press **Meas Setup 4**, then **Zero**.
7. Connect the DUT and measure.

Data Analysis Features

The following features can be used to analyze NA and CAT mode measurement results.

In this Chapter

All about Markers.....	110
About Delta Markers	111
Marker Table.....	112
Coupled Markers	112
Marker Colors	113
Marker Trace	113
Marker Format.....	114
Searching with Markers	114
What Is a 'Peak'	117
Marker Functions	118
All about Limit Lines	118
Relative Limit Lines	120
Build From Trace	120
Limit Options	121
How to Save and Recall Limits	121
All about Trace Math	122
About Math Operations.....	123

All about Markers

Markers move along the X-axis range of the measurement trace to provide a numerical readout of each measured data point. Markers also allow you to search for specific Y-axis values.

A trace can contain up to six markers.

The marker readout on the FieldFox shows X and Y-axis information for the active marker ONLY.

A Marker Table can be displayed that allows you to simultaneously view X and Y-axis information for all markers.

Markers can be used in **CAT**, **NA**, and **Pulse Measurements** Modes.

How to create Markers

- Press **Marker**.
- Then **Markers 1..6** to select a marker to activate.
- Then **Normal** to activate that marker. A marker is created on the trace in the middle of the X-axis. That marker is now **active**.
- Then move the marker using the rotary knob, the **▲▼** arrows, or by entering an X-axis position with the number keys.
- Then press **Enter**.

How to move a Marker after it is created

- Press **Marker**.
- Then **Markers 1...6** repeatedly until the marker of interest is selected. The OFF, Normal, or Delta softkey is black to indicate the current setting of each marker.
- Then move the marker as when it was first created.
- Markers can also be moved using one of the marker search functions. Learn more on page 113.

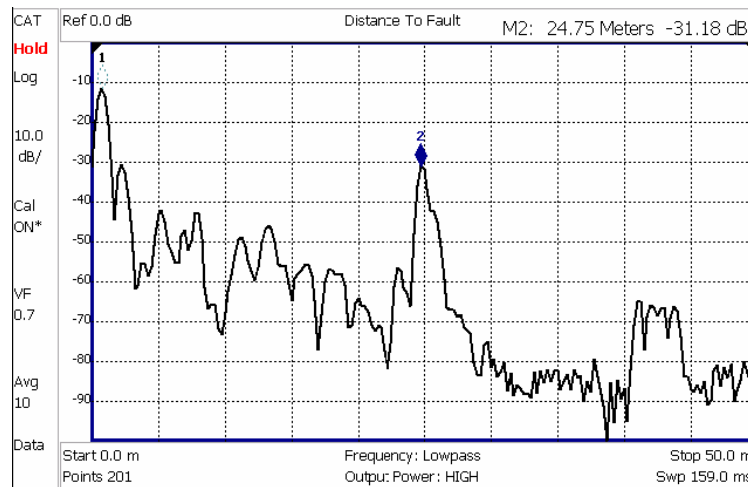

Marker 2 is active, marker 1 is NOT active.

About Delta Markers

A delta marker provides X-and Y-axis readout information that is **relative** to a 'reference' marker.

A delta marker is created with a ▲ (delta symbol) to distinguish it from the reference marker.

All six markers can be delta/reference marker pairs.

Peak search functions can be performed using delta markers. The delta marker moves to the peak;; the reference marker does NOT move.

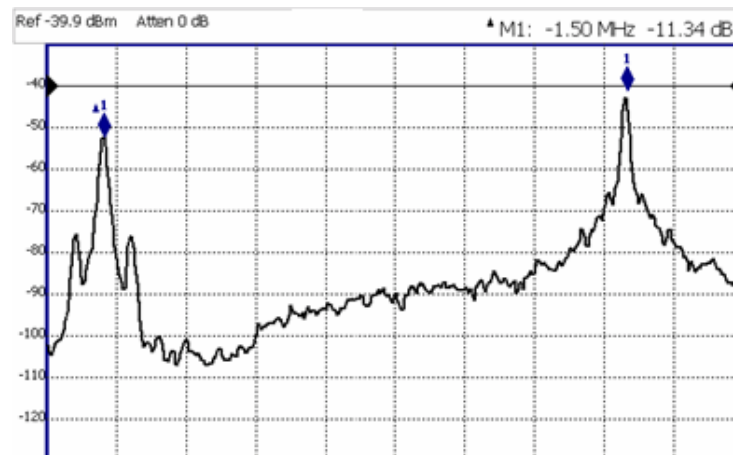

A Delta marker and its associated reference marker. The marker readout shows the difference between the two markers in frequency and amplitude.

How to Create a Delta Marker

- Create a **Normal** marker and move it to the reference position.
- Press **Delta**. The marker becomes the reference marker. It becomes fixed at its X-Axis position.
- Move the Delta marker by entering a value with the numeric keypad, by using the  arrows, or using the rotary knob.
- Press **Enter** when finished.

How to move the Reference marker

- Press **Delta** to turn the Delta marker OFF.
- Move the marker to the new position.
- Then press **Delta** again, to turn the Delta marker back ON.

Marker Table

The Marker Table can be displayed at the bottom of the FieldFox screen. It can display information for up to 6 markers in a full-width window, and up to 3 markers for a half-width window (NA mode). The marker table “squeezes” the graticule area when activated.

How to display the Marker table

- Press **Marker**.
- Then **Marker Table On Off**.

Coupled Markers

Coupled Markers, available in NA Mode only, allows you to simultaneously create and move markers that have the same number for all traces. For example, when marker 2 is created on a trace, a marker 2 is created for ALL traces. When any marker 2 is moved, they all move together to the same X-axis position.

- Coupled markers are relevant only in multi-trace configurations.
- All markers are either coupled or uncoupled. There can NOT be one marker coupled and another uncoupled.
- Peak functions move the marker to the peak on the **active trace**, while all other markers move to the same X-axis position.

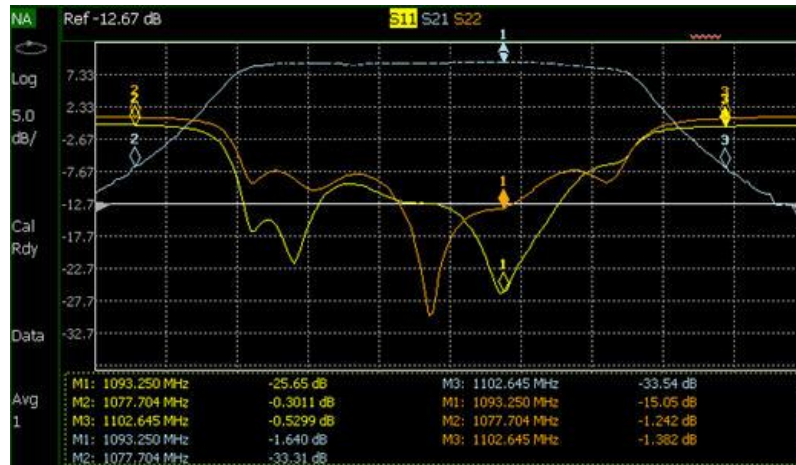

Coupled Markers move on ALL traces at the same time.

How to create Uncoupled Markers

NOTE Markers are coupled by default.

To create markers that are NOT coupled (move independently on each trace):

- Press **Marker**
- Then **More**
- Then **Coupled Markers OFF**

Marker Colors

In NA and CAT Modes, markers are the same color as the trace to which they are assigned, as shown in the above image. In SA Mode, the marker color is NOT the same as the trace.

Marker colors can NOT be changed.

Marker Trace

Both CAT and NA Modes can display a data trace and a memory trace. By default, markers are assigned to the data trace. However, you can move a marker between the data and memory trace. The marker moves to the same X-axis location on the specified trace.

When Coupled Markers is ON, this setting applies to the active marker for ALL traces that are coupled. Otherwise, this setting applies to the active marker on only the active trace.

How to move a marker between data and memory traces

- Create a data and memory trace that will host the marker. Learn how on page 122.
- Press **Marker** and **Enter** to create a marker.
- Then **More**
- Then select the marker to move using **Marker 1,2,3,4,5,6**.
- Then toggle **Marker Trace Auto Data Mem**.
 - **Auto** - Marker resides on data trace when it is visible. Marker resides on memory trace when only IT is visible.

- **Data** - Marker resides on data trace, even when not visible.
- **Mem** - Marker resides on memory trace, even when not visible.

Marker Format

The Marker Format setting, available ONLY in NA Mode, allows you to choose the format of the marker readout that appears in the upper-right corner of the screen and in the marker table. The marker format can be independent of the trace format, and can be set independently for each trace. All markers on a trace have the same marker format.

How to choose marker format

- Press **Marker**
- Then **More**
- Then **Marker Format**
- Then choose from the following:

Selection	Example Y-axis value
Default Same as displayed format	
R + jX Complex impedance format (3 rd number is distance for Time Domain)	22.8Ω -j61.4Ω 287.9fF
Z Magnitude Impedance Mag.	66.08Ω
Phase	73.8°
Real	0.2003
More	
Imaginary	-0.6727
Mag & Phase	0.705, -73.7°

To view other formats, change the trace format, then select **Default**. Learn how to change format on page 26.

Searching with Markers

Marker Searches are used to move markers to locations on the trace which exhibit the characteristics of the search criteria. Learn “What is a Peak” on page 117.

How to Search with Markers

The following menu structure applies to NA Mode. Keystrokes will be slightly different for CAT and Pulse Measurements Modes.

- Activate the marker to move. Activate the marker to be used for the search (NOT necessary with Bandwidth search.)
- Then press **Mrk ->/Tools**.
- Then **Marker Search**

- Then choose from the following:
 - **Tracking ON OFF** (NA Mode ONLY)
 - **ON** causes the active marker to search for the specified criteria with each new sweep. Search criteria can include: Target, Bandwidth, Peak, Min. The searches begin with the first sweep after Tracking is turned ON based on the current search type. The stimulus setting for a marker can NOT be changed manually. **Trk** appears next to the marker number.
 - **OFF** causes a new marker search only when the search feature is re-executed.
 - **Peak** Moves the active marker to the HIGHEST amplitude data point of the trace. The Peak Excursion value is ignored.
 - **Min** (Not available in DTF) Moves the active marker to the LOWEST amplitude data point of the trace.
 - **Target** (NA Mode ONLY) Enter the Target value. The marker moves to the first occurrence of the Target value to the right of its current position. The FieldFox interpolates between measured data points to find the exact Target value to two decimal points. The interpolated X-axis value is displayed in the marker readout or marker table. Subsequent presses of the Target softkey cause the marker to move to the right to find the next occurrence of the Target value. When the marker reaches the end of the stimulus range, it "wraps around" and continues the search from the beginning of the stimulus range.
 - **Bandwidth ON OFF** (NA Mode ONLY) Use to quickly toggle BW Markers ON and OFF. When OFF, the marker table appears showing the X and Y-axis positions of all enabled markers.
 - **Bandwidth** (NA Mode ONLY) Specify the level in dB from the peak or valley where bandwidth is measured.
 - **Negative** numbers search for a **Peak** bandpass, such as a filter S21 response.
 - Either of the following TWO methods can be used to search for a **Valley** or Notch filter, such as the S11 response of a bandpass filter.
 - **Negative** values search down from the TOP (MAX) of the response.
 - **Positive** values search up from the BOTTOM (MIN) of the notch.
 - If you first enter Negative, then Positive values, it may be necessary to press **Marker**, then **More**, then **Markers All Off**.

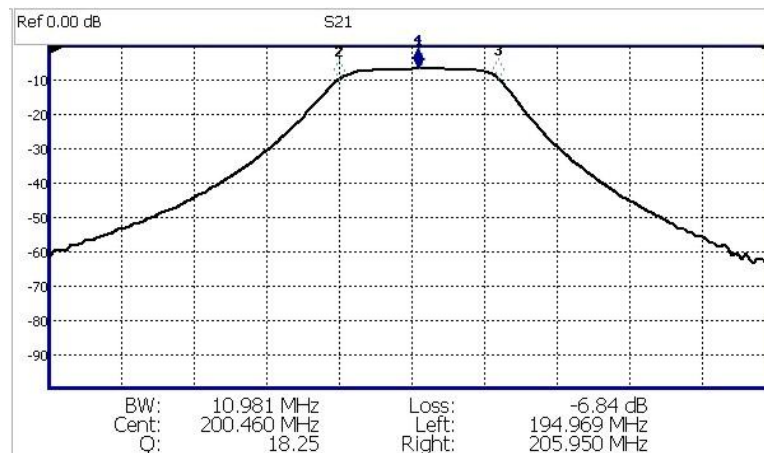

**S21 of a filter with BW Markers and associated readout values.
The search criteria is -3 dB.**

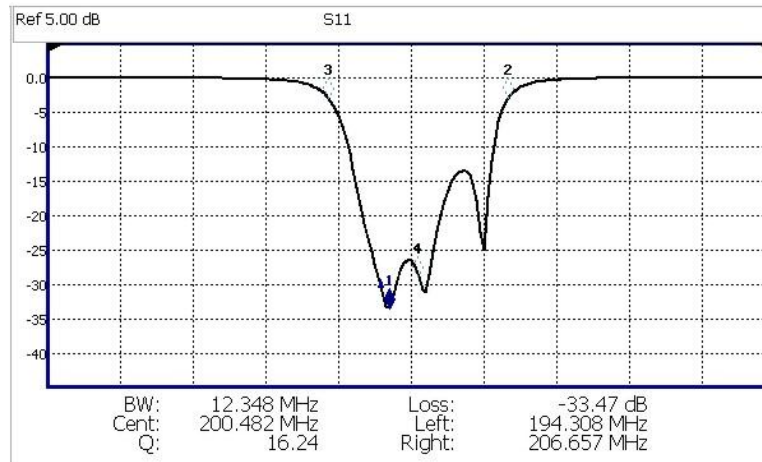

S11 of the same filter with same search criteria: -3 dB. The same values would result from a search criteria of approximately +30.4 dB.

Press **Enter** and four markers are automatically created to find the first negative or positive bandpass over the displayed frequency range.

Bandwidth Search can be used ONLY with Log Mag display format.

The following six values are displayed for Bandwidth Search:

- **BW:** Width of the filter. (marker 2 freq) minus (marker 3 freq).
- **Center:** Marker 4 frequency. Mathematical midpoint between marker 2 and marker 3.
- **Q:** Center Frequency / Bandwidth.
- **Loss:** Marker 1 amplitude.
- **Left:** Frequency of marker 2 or 3 (to left of marker 1).
- **Right:** Frequency of marker 2 or 3 (to right of marker 1).
- Press **Back** to return to the previous menu.
-
- Press **Peak Search** then choose from the following:
 - **Peak** Moves the active marker to the HIGHEST amplitude data point of the trace. Peak Excursion value is ignored.
 - **Next Peak** Moves the active marker to the next highest amplitude peak from where it currently resides.
 - **Peak Left** Moves the active marker to the next data point to the left that meets the 'Peak' criteria. When no data points to the left meet the 'Peak' criteria, the marker does not move.
 - **Peak Right** Moves the active marker to the next data point to the right that meets the 'Peak' criteria. When no data points to the right meet the 'Peak' criteria, the marker does not move.
 - **More** then **Min Search** (Not available in DTF) Moves the active marker to the LOWEST amplitude data point of the trace.

The following applies to DTF Measurements ONLY:

- **More**.
- **Track Peaks ON OFF** When Track Peaks is ON, markers will find the new peak with every sweep. While in this Mode, the markers can NOT be turned OFF or moved.
- **Find 3 Peaks** Three markers are created and find the highest peaks (faults) on the trace.

What Is a 'Peak'

You define what the FieldFox considers a "peak" by setting the Peak **Threshold** and Peak **Excursion**.

These two peak criteria settings are set individually for each trace and for each mode (CAT, SA, or NA).

These settings do NOT survive a FieldFox or Mode Preset.

NOTE The Peak Threshold and Excursion settings are NOT available in DTF measurements. To make these settings, create a non-DTF CAT mode measurement, then change the measurement back to DTF.

How to set Peak Criteria

- Press **Mrk ->/Tools**.

In CAT and NA modes:

- Then **Peak Search**.

In SA mode:

- Then **More**
- Then **Mkr Properties**

- Then **Peak Criteria**

Then select from the following:

- **Peak Threshold** Minimum amplitude (dB). To be considered valid, the peak must be **above** the threshold level. The valley on either side can be below the threshold level. Default = -190 for CAT and NA Modes; -90 for SA Mode.

Note: CAT mode Loss measurements are displayed in positive values. In these cases, the Peak Threshold setting is inverted. For example, Peak Threshold = -20 will consider any peak that has less Loss than 20 dB to be valid.

Peak Excursion The vertical distance (dB) between the peak and the valleys on both sides. To be considered a peak, data values must "fall off" from the peak on both sides by the excursion value. Default = 0.5 dB.

For **example**, the settings for the trace in the following image are:

- Threshold: -10 dB
- Excursion: 1 dB
- Scale = 1 dB / Division.

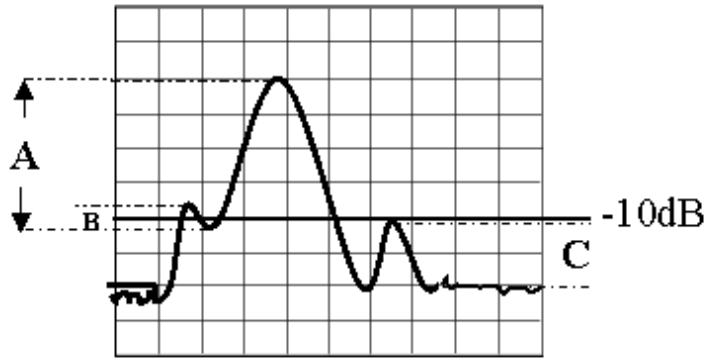

- Peak A = **Valid Peak** (Above Threshold and Excursion Settings)
- Peak B = **Invalid Peak** (Below 1 dB Excursion Setting)
- Peak C = **Invalid Peak** (Below -10 dB Threshold Setting)

Marker Functions

Marker functions are used to change FieldFox frequency or distance settings to those of the active marker.

How to use Marker Functions

- Activate the marker to move.
- Then press **Mrk ->/Tools**.
- Then choose one of the following:
 - **Mrk -> Center** (Not available in DTF mode) The center frequency of the measurement becomes the value of the active marker. The frequency span is adjusted accordingly.
 - **More** then **Mkr -> Delay** (NA mode ONLY) The group delay value of the active marker becomes the electrical delay setting of the trace. Learn how to set group delay format on page 26. Learn more about electrical delay on page 28.

The following applies to DTF Measurements ONLY:

- **More** then:
 - **Marker=>Start Distance** The Start Distance of the measurement becomes the value of the active marker. Markers that would no longer appear on the screen are moved to the new Start Distance.
 - **Marker=>Stop Distance** The Stop Distance of the measurement becomes the value of the active marker. Markers that would no longer appear on the screen are moved to the new Stop Distance.

All about Limit Lines

Limit lines are visual representations, drawn on the FieldFox screen, of the specified limits for a measurement. With this capability, you can easily compare measured data versus specifications. Optionally, you can enable an audible beep and display **Pass or Fail** information for each measurement.

- You can have up to as many limit line segments as there are data points for each measurement trace allowing you to test all aspects of your measurements.

- Limit lines are available in CAT Mode and NA Mode. Power Meter Mode uses different limit settings. Learn more on page 83.
- Limit lines and limit testing are NOT allowed in NA Mode with **Smith Chart** or **Polar** display formats.
- Limit lines can be saved and recalled with an *.sta file. Learn more on page 124. They can also be saved and recalled independently from the Limit softkeys. Learn more on page 121.

How to Create Fixed Limit Lines

There are two ways to build a Fixed limit line:

1. Build (limits) From a Trace. Learn how on page 120
 2. Enter X/Y data points into the on-screen editor. The limit line is formed as the FieldFox 'connects the dots' on the screen. To create frequency gaps that are NOT tested, use separate limit lines. The X-axis values for two lines can overlap.
- Press **Limit 8**.
 - Then **Edit Limits**. A limit line table appears.
 - Use the Up / Down arrows and rotary knob to navigate the cursor to the following editable cells.
 - **Description** - Press **Edit**, then enter a description for the limit line using the FieldFox labeler (learn how on page 124).
 - **Fixed/Relative** - Press **Edit** to toggle between the following:
 - **Fixed** - the limit line does not move. The X/Y coordinates are absolute locations on the screen.
 - **Relative** - the limit line moves relative to the center frequency and reference level. **Note:** It is easiest to first create Fixed Limits, then change this setting to Relative. Learn more on page 120.
 - **Upper/Lower** - Press **Edit** to toggle between the following:
 - **Upper** - FAILS any measured data point **ABOVE** the line.
 - **Lower** - FAILS any measured data point **BELOW** the line.
 - **Off/On** - Press **Edit** to toggle between the following:
 - **On** - Limit line is drawn on the screen and PASS/FAIL testing occurs.
 - **Off** - Limit line is NOT drawn on the screen and testing does NOT occur.
 - **Frequency** - Enter a numeric X-axis value of the data point.
 - **Amplitude** - Enter a numeric Y-axis value of the data point.
 - Press **Add** then choose from the following:
 - **Add Point** - Adds a blank X/Y data point below the cursor.
 - **Add Limit** - Adds a default limit line below the current limit.
 - Press **Clear** then choose from the following:
 - **Clear Point** - Removes the X/Y data point on which the cursor resides.
 - **Clear Limit** - Removes the limit Line on which the cursor resides.
 - **Clear All** - Removes ALL limit lines.

- Press **<Back** to return to the Limit menu.

Relative Limit Lines

Relative limit lines are X/Y coordinates that are referenced to the center frequency (X-axis) and Reference level (Y-axis).

Use relative limits to test devices or signals that are identical except for the center frequency or amplitude. With relative limit lines in place, you change the center frequency of the measurement and the limits look as though they are in the same location.

The same is true for Reference Level. When you expect to measure a different power level, instead of changing the Y-axis value of all of the fixed limits, simply change to relative limits. The limits will then remain a constant Y-axis distance from the Reference Level.

Each limit line can be changed at any time from Fixed to Relative, and Relative to Fixed.

How to Create a Relative Limit Line

The easiest way to create a Relative limit line is to create a Fixed Limit at a specific center frequency and reference level. Learn how on page 118. Then change the limit line to Relative. The X/Y data points will be re-calculated relative to the center frequency and reference level.

Build From Trace

A limit line can be built from an existing trace. One X/Y point is made from each measured data point. Then, using an offset value, you can shift the limit line UP for upper limits or DOWN for lower limits.

Once limit lines have been built from the trace, changes that you make to the trace, such as frequency range, do NOT change the limits. However, the limit line properties can be edited just like standard limit lines.

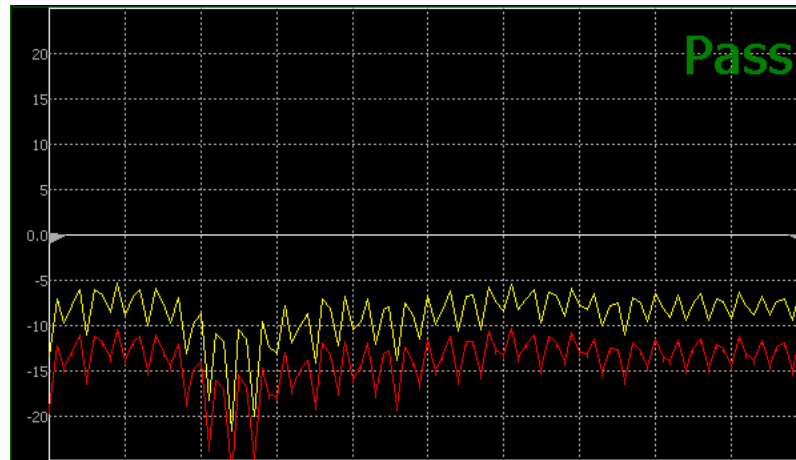

A lower limit line (red) built from the trace (yellow) shifted down 5 dB.

How to Build Limit Lines from a Trace

NOTE Build from Trace is NOT allowed for traces with more than 1001 data points.

- Select the trace from which limits will be built.
- Press **Limit 8**.

- Then **Edit Limits**.
- Then **Build From Trace**. A limit line table appears.
- Use the **▲▼** arrows to select ON.
- Use **Offset** to shift the limit line UP or DOWN. Learn how below.

Limit Options

How to set Limit Options

- Press **Exit** if the limit table is visible.
- Then **Options**.
- Then choose from the following:
 - **Beep**
 - **On Pass** Audible beep sounds when a sweep passes.
 - **On Fail** Audible beep sounds when a sweep fails.
 - **Off** No audible beep sounds.
 - **Warning On Off** Shows **Pass** or **Fail** indication on the display with each sweep. Data points that fail are highlighted.
 - **Limit Type**
 - **Offset** Shifts the limit line up or down. Enter an offset value using the rotary knob, the **▲▼** arrows, or by entering a value with the number keys.
 - Enter a **positive** offset to shift the limit line UP, usually used with UPPER limits.
 - Enter a **negative** offset to shift the limit line DOWN, usually used with LOWER limits.
 - **Margin** Shifts the limit line up or down like an offset, but only virtually. The limit line does NOT appear to move. Enter a Margin value using the rotary knob, the **▲▼** arrows, or by entering a value with the number keys.
 - Enter a **positive** margin to virtually shift the limit line UP.
 - Enter a **negative** margin to virtually shift the limit line DOWN.

How to Save and Recall Limits

In addition to saving and recalling limits with an *.sta file, limit lines can also be saved and then recalled independent of the current mode or measurement. Use this feature to recall and apply existing limit lines to measurements with different settings or even a different frequency range.

Limit line files can be loaded into the FieldFox Data Link Software. Learn how in the help file that is included in the Data Link software.

How to Save and Recall Limits

- Press **Save/Recall** then **Select Device** to set the Device (Internal, SD card, or USB flash drive) to be used for the Save or Recall. Learn more on page 126.
- Then press **Limit**.
- Then choose from the following:

- **Save Limits** After limit lines have been defined, this saves the line definition to a file on the specified device.
- **Recall Limits** Recalls a limit Line definition from the specified device.

All about Trace Math

Trace Math is available ONLY in **CAT** and **NA** Modes, but not in DTF measurements.

A trace is a series of measurement data points that are connected to form a line. This 'live' data trace is updated as data points are measured.

A memory trace is a live trace that has been stored in the FieldFox volatile memory. It then becomes static, meaning it is not updated with measurements. It can be displayed on the screen by itself, or with a data trace for comparison purposes.

- In NA mode, memory traces are the same color as data traces, but muted (duller).
- In CAT mode, the data trace is displayed in **yellow** and the memory trace is displayed in **blue**.

How to display data and memory traces

- Press **Trace 6**.
- Then **Data->Mem** to store the ACTIVE data trace into memory. A 'beep' sounds to confirm the data trace has been stored to memory. There is no display annotation that indicates that the memory trace has been stored.
 - Press **Data** to view only the data trace. **Data** is annotated in the left pane.
 - Press **Memory** to view only the memory trace. **Mem** is annotated in the left pane.
 - Press **Data & Memory** to view both the data trace and the stored memory trace. **Data&Mem** is annotated in the left pane.

How to perform Trace Math

Trace math is performed between a data trace and a memory trace. When one of the following math operations are selected, the data trace displays the current measurement with the selected trace math applied. The math operation symbol indicated below in [brackets] is displayed in the left pane.

- Press **Trace 6**.
- If not already stored, press **Data->Mem** to store the current data trace into memory.
- Then **Data Math**.
- Then choose one of the following:
 - **Data + Memory** [D+M] Current trace data **added to** memory data.
 - **Data – Memory** [D-M] Current trace data **subtracted from** memory data.
 - **Data / Memory** [D/M] Current trace data **divided by** memory data.
 - **Math Off** [Data] Displays trace data with NO math applied.

About Math Operations

Data / Memory and **Data - Memory** math operations are performed on complex linear data before it is formatted. Because data is often viewed in log format, it is not always clear which of the two math operations should be used. Remember: dividing linear data is the same as subtracting logarithmic data. The following illustrates, in general, when to use each operation.

Use **Data / Memory** for normalization purposes, such as when comparing traces "before" and "after" a change is made or when measuring trace noise. In the following table, the Data/Mem values intuitively show the differences between traces. It is not obvious what Data-Mem is displaying.

Values to compare	Data/Mem	Data-Mem
0.5 dB and 0.6 dB	0.1 dB	-39 dB
0.5 dB and 0.7 dB	0.2 dB	-33 dB

Use **Data - Memory** to show the relative differences between two signals. Use for comparison of very small signals, such as the S11 match of two connectors.

In the following table, Data/Mem shows both pairs of connectors to have the same 2 dB difference. However, the second pair of connectors have much better S11 performance (-50 and -52) and the relative significance is shown in the Data-Mem values.

Values to compare	Data/Mem	Data-Mem
-10 dB and -12 dB	2 dB	-24 dB
-50 dB and -52 dB	2 dB	-64 dB

File Management

The FieldFox can save any of the following types of files:

- Current settings and calibration
- Trace data (*.csv and *.S1P)
- Picture of the FieldFox screen

In addition, files can be saved to the internal memory, a USB Flash drive, or a micro SD card.

In this Chapter

Save Files	124
Recall Files	125
Set File Type and Device	126
Manage Files	128
Manage Folders	128
Edit Keywords	129
Prefixes for Filenames	129
Printing.....	130
See Also	
Erase User Data	145

Saving and Recalling Files

NOTE FieldFox State files are intended to be recalled on the same instrument model on which they were saved. Sometimes you may be able to recall them within model families. An error will result when trying to recall a state file that was saved on a different model family.

- The FieldFox model families are:
- N991x (VNA/SA) model family
- N992x (VNA) model family
- N993x (SA) model family

Save Files

How to Save a File

- Press **Save/Recall 9**.
- Then **Save**.
- At the top of the current 'labeler' screen (see following image) check the **File Type** to save and **Device** (Internal, USB, Storage Card) to which the file is saved. Learn how to change these settings on page 126.
- Then use the labeler to specify a filename.

NOTE Insert only ONE USB Flash Drive in the FieldFox when saving or copying files.

How to name files

The labeler is used to edit or change the current filename. It is also used to create a title, prefix, and keyword to display on the FieldFox screen. Learn about Titles on page 134.

- Press **Select** to add the cursor character to the end of the existing filename.
- Press **Backspace** to erase the last character from the current filename.
- Press **Clear** to erase the current filename.
- The preselected keywords (File, Site, and so forth) can be selected just like a single character. These keywords can also be edited. Learn more on page 129.

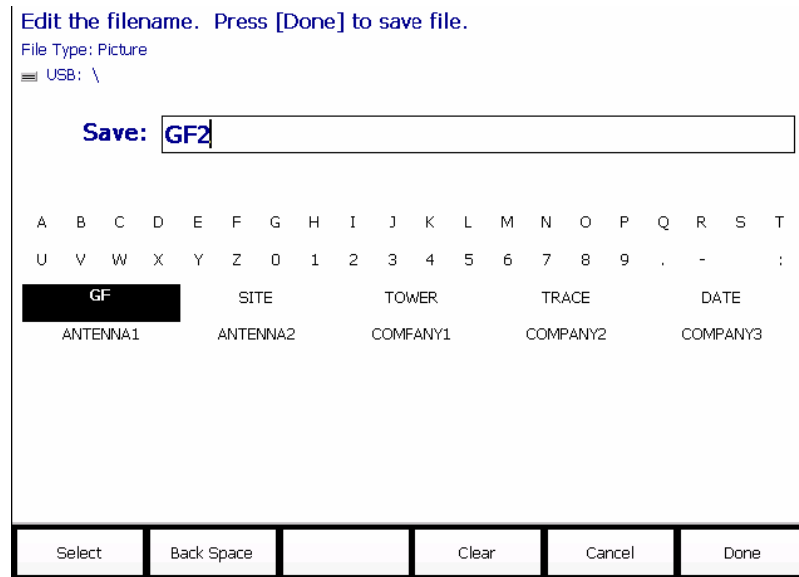

The FieldFox labeler. The current filename is GF2. The cursor is on the custom GF keyword. The file will be saved to USB (flash drive). File Type is "Picture".

How to move the cursor

- Use the rotary knob to move cursor on the same row. The cursor will change rows when it comes to a row end.
- Use the **▲|▼** arrows to move the cursor up and down the rows.

When the current filename is complete

- Press **Done** to save the file to the specified filename. If the filename already exists, a warning is displayed.
- Press **Cancel** to close the labeler without saving a file.
- If the filename already exists, you are prompted to choose from the following:
 - Press **Yes** to overwrite the existing file.
 - Press **Cancel** to edit the filename.

Recall Files

The FieldFox can recall **State** files, **Trace + State** files, and image files.

State Files

ALL FieldFox instrument settings for ALL Modes are saved and recalled in a *.sta file. If error correction is ON in CAT or NA Mode, then calibration data is also saved and recalled.

If error correction is OFF (CalRdy is active), calibration data is NOT saved in the *.sta file. When a Trace + State file is recalled on a FieldFox other than the one it was saved on, differences in the CalRdy calibration data may result in differences between the displayed traces.

Image Files

The FieldFox can open and display *.png, *.jpg, and *.jpeg files.

How to Recall an *.sta File

NOTE Before recalling a file, first set **File Type** to State or Trace + State, and also **Select Device** from which the file will be recalled.

- Press **Save/Recall 9**.
- Then **Recall**.
- Navigate to the file to be recalled using the Up/Down arrow keys.
- Then **Recall File** or **Enter**.

Set File Type and Select Device

The following File TYPE and DEVICE settings are used to determine the type of file to save, and the location to be used for all file operations.

These two settings remain through an instrument preset, but are reset to the default values when the FieldFox power is shutdown.

Select Device (location of File Save/Recall)

- Press **Save/Recall 9**.
- Then **Select Device** to set the **LOCATION** where the file is to be saved. Choose from the following:
 - **Internal** Saves/Recalls files to/from the FieldFox internal memory. To specify a folder, first select Manage Folders (learn how on page 128). The Data Link software will read data ONLY from the \UserData folder.
 - **SD Card** Saves/Recalls files to/from the micro SD card (not included), inserted in the card slot. See FieldFox Tour on page 15. Only the root folder is available.
 - **USB** Saves/Recalls files to or from a USB Flash drive (not included) that is inserted in one of the USB connectors. Only the root folder is available.

NOTE Insert only ONE USB Flash Drive in the FieldFox when saving or copying files.

How to set File Type

State files are the only file type that can be recalled by the FieldFox.

- Press **Save/Recall 9**.
- Then **File Type**. Choose one of the following:
 - **State** Saves ALL FieldFox instrument settings for ALL Modes to a *.sta file. If a calibration is ON in CAT or NA Mode, calibration data is also saved. This file can be opened ONLY by a FieldFox.

- **Trace + State** Saves the current trace and instrument settings to a *.sta file. This file can be opened ONLY by a FieldFox. When recalled, the FieldFox sweep is set to Hold.
- **Picture** Saves a 640 x 453 pixel image of the FieldFox screen to a *.png file. The picture does NOT include the softkeys.
- **Data (S1P) / (2P)** Saves **CAT** and **NA** Mode trace data to an *.S1P or *.S2P file, depending on the active measurement. This file format is used by CAE programs such as Keysight's Microwave Design System (MDS) and Advanced Design System (ADS). It can also be imported into spreadsheet software such as Microsoft Excel.
 - Choose S1P to save data for the active data trace.
 - Choose S2P (NA Mode ONLY) to save the four S-parameters: S11, S21, S12, and S22. Zeros are returned for parameters that are not displayed, except if full 2-port correction is ON (option 122). In this case, corrected data for all S-parameters is returned, even if not displayed.

About SNP Files

- The SNP file includes header information, and the following data:
 - S1P - saves 1-port (receiver) data for the active data trace. *.s1p Files contain 1 stimulus value and 1 S-parameter (total of 3 scalar values) **Stim Real(Sxx) Imag(Sxx)**
 - S2P (NA Mode ONLY) - saves data for two S-parameters (S11, S21) if they are both displayed. *.s2p Files contain 1 stimulus value and 4 S-parameters (total of 9 scalar values) **Stim Real(S11) Imag(S11) Real(S21) Imag(S21) Real(S12) Imag(S12) Real(S22) Imag(S22)**
 - When parameters are corrected, data is returned even when not displayed. When parameters are NOT corrected or displayed, and the format is Mag/Phase, zero-filled data appears as 0 dB and 0 degrees. When the format is Real/Imaginary, zero-filled data appears as (1,0).
- Data is returned with the correction type that is applied for each S-parameter. The correction type for each S-parameter is annotated in the header.
- Only the data trace is saved – not the memory trace.
- In CAT Mode, S1P files are always Magnitude(dB) / Phase (angle) format.
- In NA Mode, SNP files for traces in Smith Chart or Polar format saves Real/Imaginary format. All other trace formats are saved in Mag/Phase format.
- Trace Math is ignored when saving data to an SNP file.
 -
 - **Data (csv)** Saves trace data from the current mode to a *.csv file. This format can be imported into spreadsheet software such as Microsoft Excel.
 - In **CAT Mode**, only the single data trace is saved – not the memory trace.
 - In **NA Mode**, all displayed data traces are saved – not the memory traces.
 - In **Power Meter and VVM Mode**, NO data is saved.

Manage Files

Files that are stored in the FieldFox internal memory, micro SD card, and USB Flash drive, can be copied to another device or deleted.

How to Manage files

- Press **Save/Recall 9**.
- Then **Select Device** to select the location (Internal, USB, or micro SD Card) of the file to copy or delete.

NOTE When selecting **Internal**, it may also be necessary to first select **Manage Folders** to specify an active folder which contains the files to copy or delete.

- Then **More**.
- Then **Manage Files**.
- Then choose from the following:

NOTE For **Copy File** and **Copy All Files**, files are always copied to a subdirectory titled Copy_<date.time stamp> of when the file was copied. For example, "Copy_June.27.2013-00.40.47". A new subdirectory is created every time a file is copied. Files can NOT be copied to other folders. To get a file to a different folder, it must be saved to the specified folder.

- **Copy File** Select a file to copy. Then select a device to copy the file to. Choose from **Internal**, **USB** (must be inserted), or **SD Card** (must be inserted).
- **Copy All Files** All files that appear will be copied. Then select a device to copy the file to. Choose from **Internal**, **USB** (must be inserted), or **SD Card** (must be inserted).
- **Delete File** The **selected** file is deleted after a warning prompt is displayed.

NOTE Insert only ONE USB Flash Drive in the FieldFox when saving or copying files.

Manage Folders

You can create new folders, delete old folders, and select the active folder to which files can be saved. The Parent folder [...] is listed when not in the root directory.

How to Manage Folders

- Press **Save/Recall 9**.
- Then **More**.
- Then **Manage Folders**.
- Then choose from the following:
 - **Change Folder** Changes the active folder to which files can be saved. The active device and current folder is displayed at the top of the screen. Use the **▲▼** arrows to highlight a folder within the current folder. Each time the **Change Folder** softkey is pressed, the highlighted folder becomes the active folder.
 - **Create Folder** A new folder is created in the current folder. Select a name for the new folder from one of the displayed keywords: You can change these keywords using the following **Edit Keywords** function.
 - **Delete Folder** The **selected** folder and its contents are deleted after a warning prompt is displayed. A "Parent" folder or system folder can NOT be deleted.

- Press **Exit** when finished.

Edit Keywords

The preselected keywords (FILE, SITE, and so forth) can be edited to meet your specific needs. Your keywords will remain in the FieldFox until you change them. Keywords are limited to 30 characters.

How to edit keywords

- Press **Save/Recall 9**.
- Then **More**.
- Then **Edit Keywords**.
- Then **Next Page** and **Previous Page** to view all keywords.
- Use the **▲|▼** arrows to select a keyword to edit.
- When a keyword is selected, then press **Edit**.
- Then choose from the following:
 - Press **Select** to add the cursor character to the end of the selected keyword.
 - Press **Backspace** to erase the last character from the end of the selected keyword.
 - Press **Clear** to erase the selected keyword.

How to move the cursor:

- Use the rotary knob to move the cursor along the same row. The cursor will change rows when it comes to a row end.
- Use the **▲|▼** arrows to move the cursor up and down between rows.

When the selected keyword is complete:

- Press **Done** to save all keywords and close the Edit Keywords labeler. These keywords will exist on the FieldFox until changed.
- Press **Cancel** to close the labeler without saving changes.

Prefixes for Filenames

A prefix is used as a default filename to which characters can be added. The prefix can be customized, and quickly enabled or disabled. When enabled, the current prefix is automatically entered as the start of a filename when performing a Save operation.

How to enable and disable the current Prefix

- Press **Save/Recall 9**.
- Then **More**.
- Then **Prefix ON OFF**. The current selection is underlined.

How to edit the current Prefix

- Press **Save/Recall 9**.
- Then **More**.

- Then **Prefix**.
- Then choose from the following:
 - Press **Select** to add the cursor character to the end of the Prefix.
 - Press **Backspace** to erase the last character from the end of the Prefix.
 - Press **Clear** to erase the Prefix.
 - The preselected keywords (File, Site, and so forth) can be selected just like a single character. These keywords can also be edited. See **Edit Keywords**.

How to move the cursor

- Use the rotary knob to move cursor on the same row.
- Use the **▲|▼** arrows to move the cursor up and down the rows.

When the Prefix is complete

- Press **Done** to save the Prefix and close the labeler. This Prefix will exist on the FieldFox until it is changed.
- Press **Cancel** to close the labeler without saving changes.

Printing

The current screen or selected files can be printed using a PCL-compatible printer (like the older HP Deskjet printer) connected to one of the FieldFox USB ports. Newer PCL3GUI photo and all-in-one printers are NOT supported.

Measurements can also be printed using the FieldFox Data Link software.

How to print the current screen or a saved file.

To save ink, first select an outdoor (white background) display color. Learn how on page 134.

- Connect the printer to a FieldFox USB port. **The print softkey will appear ONLY when a compatible printer is connected.**
- Then press **Save/Recall 9**
- Then **Print** and choose from the following:
 - **Printer and Page Setup** - Confirm that that printer is connected and configured properly. The Status line should read "Ready".
 - Make other print settings as desired.
 - **Select Files for Printing** - Print up to 16 *.PNG images on one page that are stored on the Internal drive. Images can NOT be printed from the USB and SD card.
 - Edit the Quick Settings table to select up to FOUR Rows and FOUR Columns for up to 16 total images to be printed on a single page.
 - If necessary, edit the filenames to be printed.
 - Select **Done**. Then **Print Selected Files** to begin printing.
 - **Print Current Screen** - Immediately prints the FieldFox screen using the selected Printer and Page Setup settings.

System Settings

In this Chapter

Run/Hold	131
Preset	132
User Preset	132
Volume Control	132
Display Settings	132
Brightness	133
Colors	133
Trace Width	134
Title	134
Edit Keywords	135
Full Screen Mode	135
Preferences	
Quick Settings Table	135
Save and Reset Preferences	136
Startup Mode	137
Language	136
Battery Saver	137
System Configuration	
Options (Licensing)	138
GPS	139
Frequency Reference Source	140
Security Level	141
Date and Time Settings	142
LAN Settings	143
Power ON	144
Service Diagnostics	144
Erase User Data	145
See Also	
Battery Usage	12
FieldFox Internal Temperatures	14

Run/Hold

The **Run/Hold** key determines whether the FieldFox sweeps continuously or does NOT sweep, but holds the display results of the last sweep that was performed.

Use **Hold** to conserve battery power or to allow you to save or analyze the results of a specific measurement sweep.

The current sweep mode is shown on the screen as:

-  Continuous
- **Hold** Hold

- --> is displayed while a single sweep occurs.

How to perform a single sweep while in Hold

- Press **Sweep 3**.
- Then choose one of the following:
 - **Single** Automatically sets Continuous OFF (Hold) and causes FieldFox to make ONE measurement sweep, then hold for the next Single key press.
 - **Continuous** Makes continuous sweeps. This is the typical setting when battery power is not critical.

Preset

The Preset key restores the FieldFox measurement settings to a known condition. You can preset the entire instrument, or just the current Mode (CAT, Power Meter, NA.)

When Preset, the FieldFox becomes CalReady at the test ports. Learn more on page 63.

The following settings always survive Preset and/or Mode Preset:

- External Reference state (page 139);
- Marker Peak Excursion and Threshold (page 117).
- VVM Display Resolution (page 104).
- Volume Control

How to Preset the FieldFox

- Press **Preset**.
- Then choose one of the following:
 - **Preset** Returns ALL Modes to the factory default settings.
 - **Mode Preset** Returns only the current Mode to the factory default settings. The current settings for all other Modes remain.

User Preset

User Preset allows you to store custom settings for each mode, then recall the settings when the Preset key is pressed. Your custom settings are saved to a standard State file (UserPreset.sta). However, unlike State files, calibration data is NOT saved. Learn more about State files on page 126.

How to set User Preset

- Make your custom settings for all modes.
- When finished, press **Preset .**
- Then **Save User Preset**, then select **Yes** to confirm.
- Then **User Preset ON**

How to recall User Preset

- Press **Preset .**

- Then choose from the following:
 - **Preset (User)** The entire UserPreset.sta file is recalled. ALL modes assume the settings that were in place when the User Preset was saved. The active mode is the mode that was visible when the file was saved.
 - **Mode Preset (User)** The settings for only the current mode are recalled from UserPreset.sta.

NOTES

- Only the instrument settings are saved to UserPreset.sta. No trace data or calibration data is saved.
- User Preset ON / OFF is saved as a Preference setting. Like all preferences, this setting survives a FieldFox shutdown and power ON. Therefore, when User Preset is ON during shutdown, the FieldFox will load UserPreset.sta when it is powered ON.
- To return to Factory Preset, select **User Preset OFF**. The contents of UserPreset.sta remain stored on the FieldFox. When User Preset is OFF, you can also set the Startup Mode preference that determines which mode will be visible after powering ON. Learn more on page 137.

Volume Control

System volume control is a FieldFox global setting which sets speaker volume for ALL success beeps, key press clicks, and individual features that use the FieldFox speaker.

The volume control setting remains through a FieldFox Preset. To cause your volume control setting to remain through a FieldFox shutdown, save the setting as a Preference. Learn how on page 135.

How to set FieldFox Volume Control

- Press **System 7**
- Then **Volume**
- Then use the **▲▼** arrows, the rotary knob, or numeric keypad to enter a value between 0 (lowest volume) and 100 (highest volume).
- Press **Volume** again and select **Mute** to quickly turn OFF the speaker volume. Press **Volume** again to set volume ON to the previous volume control.

Display Settings

You can adjust the FieldFox for optimum viewing in a wide range of lighting conditions.

Display settings remain through a FieldFox Preset. To cause the display brightness, color settings, and trace width to remain through a FieldFox shutdown, save the display settings as Preferences. Learn how on page 135.

NOTE Clean the transfective screen with gentle and minimal wiping using Isopropyl alcohol applied to a lint-free cloth.

Display Brightness

Change the brightness of the background.

How to set Display Colors

- Press **System 7**
- Then **Display**
- Then **Brightness**
- Use the **▲|▼** arrows, the rotary knob, or numeric keypad to enter a value between 0 and 100%.

Display Colors

Change Display Colors to alter the viewing scheme.

How to set Display Colors

- Press **System 7**
- Then **Display**
- Then **Display Colors**
- Then choose one of the following:

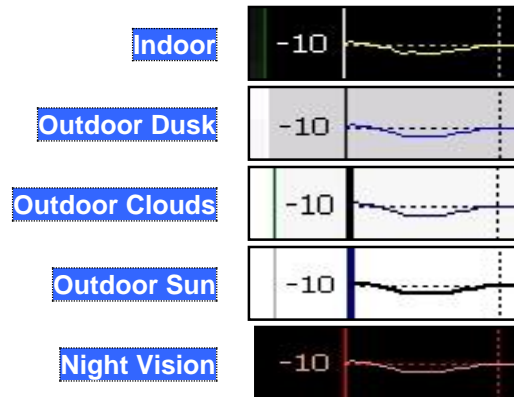

Trace Width

You can set width of all displayed traces on the FieldFox. This may allow better viewing or enhance the look of screen images. This setting can be saved with Preferences.

How to set Trace Width

- Press **System 7**
- Then **Display**
- Then **Display Colors**
- Then **More**
- Then **Trace Width**
- Then choose one of the following:
 - **Normal** - Standard width.
 - **Wide** - Enhanced width.

Title

A custom title can be made to appear in the upper-left corner of the FieldFox screen. The title can contain up to approximately 65 alpha-numeric characters. To view the Title area, see the Screen Tour on page 18.

How to add or edit a Title

- Press **System 7**
- Then **Display**.
- Then **Title**.
- Then enter or edit a title using the FieldFox labeler. This is the same labeler function that is used to name files. Learn how to use the labeler on page 124.
- Then **Title ON OFF** to make the title appear and disappear from the screen.

Edit Keywords

During a file save operation, keywords can be quickly appended to other text to create unique filenames. The Edit Keywords feature allows you to create custom keywords. Learn all about Edit Keywords on page 129.

Full Screen Mode

Full Screen Mode maximizes the display of the active trace. The screen annotations and the soft keys are removed.

How to set Full Screen Mode

- Press **System 7**
- Then **Full Screen**.

To **Exit** full screen Mode, press any key.

Preferences

FieldFox preferences are settings that survive a shutdown. When your FieldFox is turned OFF, then back ON, these settings remain. All preference settings can be restored to their factory defaults. Learn how on page

There are two ways to make FieldFox preference settings:

- From softkey selections throughout the FieldFox menu structure. Do this to temporarily try a setting, then press Save Current Settings (as preferences). Learn how in the next section.
- From the Quick Settings table.

Quick Settings Table

All preferences can be set from the Quick Settings table. They are immediately saved as Preferences when **Done** is pressed.

How to view and change Preference Quick Settings

- Press **System 7**
- Then **Preferences**
- Then **Preferences**

- Press **Next Page** and **Previous Page** to view all settings.
- To change a setting:
 - Use the **▲▼** arrows to highlight a setting.
 - Then press **Edit**. The current setting changes to **yellow**.
 - Some settings require you to press a softkey to change the value. Otherwise, use the numeric keypad, **▲▼** arrows, or rotary knob to change the value.
 - When finished changing a value, press **Done Edit**.
 - When finished changing ALL preferences, press **Done**. All changes are immediately saved as Preferences.
- To exit the editing session without saving changes, press **Esc** at any time.

Learn more about these preference settings:

Setting	Learn more...
Language	on page 136
Display Settings	on page 133
Audio	on page 132
Date and Time	on page 142
GPS	on page 139
CAT Distance Units	on page 46
Battery Saver	on page 137

Save and Reset Preferences

All preference settings can be made at one time from the Quick Settings table. All settings that can be saved as preferences (except Battery Saver) can also be made from individual softkey selections throughout the FieldFox menu structure. However, they ONLY remain set through a FieldFox shutdown when the current settings are saved as preferences.

- The table above shows a list of all of these settings and where they are discussed in this User's Guide.

How to save current settings as Preferences

- Using softkeys, configure the settings as you would like them to remain.
- Press **System 7**
- Then **Preferences**
- Then **Save Current Settings**. There is a beep when your settings have been saved.
- Press **Reset Preferences** to restore the factory default settings.

Language

Choose the language in which to display FieldFox softkeys and other messages.

How to select a Language

- Press **System 7**.
- Then **Preferences**.
- Then **Language**.
- Then choose from the following:
 - **English**
 - **Espanol** – Spanish
 - **Deutsch** – German
 - **Italiano** – Italian
 - **Francais** – French
 - **Russian**
 - **Japanese**
 - **Chinese**
 - **Turkish**

Startup Mode

The Startup Mode setting determines the mode that becomes active (visible) when User Preset is set to OFF (Factory Preset) and the FieldFox is powered ON. Learn more about User Preset on page 126.

How to set Startup Mode

- Press **System 7**
- Then **Preferences**
- Then **Preferences**
- Then scroll to **Startup Mode** and press **Edit**.
- Then repeatedly press the **Startup Mode** to scroll through the available choices.
 - **<Default>** is the factory default mode for your FieldFox model.
 - Built-in Power Meter Mode is NOT allowed as a Startup Mode.

Battery Saver

When the battery saver is OFF, the source power is left ON at the end of the sweep which consumes more power. This feature is used in CAT, NA and VVM modes.

How to set Battery Saver

- Press **System 7**
- Then **Preferences**
- Then **Battery Saver**
 - **ON** – Default setting. To conserve battery power, the RF source power is turned OFF at the end of each CAT, NA, and VVM mode sweep. This behavior does not impact FieldFox measurements.

- **OFF** – Source power is kept ON at all times, including during trigger Hold mode and between single sweep acquisitions. The RF source stays at the stop frequency until another sweep begins. This provides a constant, uninterrupted RF output from the current source port: PORT 1 with forward measurements or PORT 2 with reverse measurements (Opt 122). This behavior also provides the highest trace stability sweep-to-sweep which may only be evident while using either single sweep or Run/Hold. With Battery Save OFF, the use of a full battery charge is reduced by approximately 45 minutes.

System Configuration

Options (Licensing)

You can view and install options on your FieldFox. See all available options on page 8.

How to view the Installed Options

- Press **System 7**
- Then **System Configuration**
- Then **Options(Licensing)**
- Then **Show Options**

The currently installed options are listed.

How to Install Options

A .lic file must already be on a USB Flash Drive. To learn how to obtain a .lic file, visit: <http://www.keysight.com/find/softwarelicense>

Insert the USB Flash Drive in the FieldFox.

- Press **System 7**
- Then **System Configuration**
- Then **Options**
- Then **Install Options** The FieldFox reads, validates, then installs the options.
- Press and hold the power button to shutdown, then restart the FieldFox.

How to Delete ALL Options

Deleting individual options is NOT supported.

- Press **System 7**
- Then **System Configuration**
- Then **Options**
- Then **Advanced**
- Then **Delete All Options**

After a warning message, all options on the FieldFox are deleted.

NOTE **Delete All CFG Options** is to be used by Service Personnel ONLY.

GPS

GPS (Global Positioning System) allows you to 'stamp' each data trace with your physical position in latitude/longitude/elevation format. This can be useful when making measurements on cell towers or other antennas at remote locations.

NOTE This feature is usable ONLY with the GPS receiver that is shipped with Microsoft "Streets and Trips" and "AutoRoute". The GPS receiver is NOT available from Keysight. Only the GPS USB receiver is used with the FieldFox. Therefore, it is NOT necessary to purchase the very latest version of the map software.

- GPS can be used in all FieldFox modes.
- Your GPS settings can be saved with Preferences. Learn more on page 135.

How to make GPS settings

- Press **System 7**
- Then **System Configuration**
- Then **GPS**
- Then choose from the following:
 - **OFF** - Disable GPS (default setting).
 - **External** - Enable GPS using an external, customer-supplied, USB dongle device. When enabled, a check is made to detect a USB GPS device at the USB connectors. When a device is detected, a search is made for satellites overhead. The GPS works best when outdoors and in full view of the open sky. When several satellites are found, the following screen appears and is updated frequently:

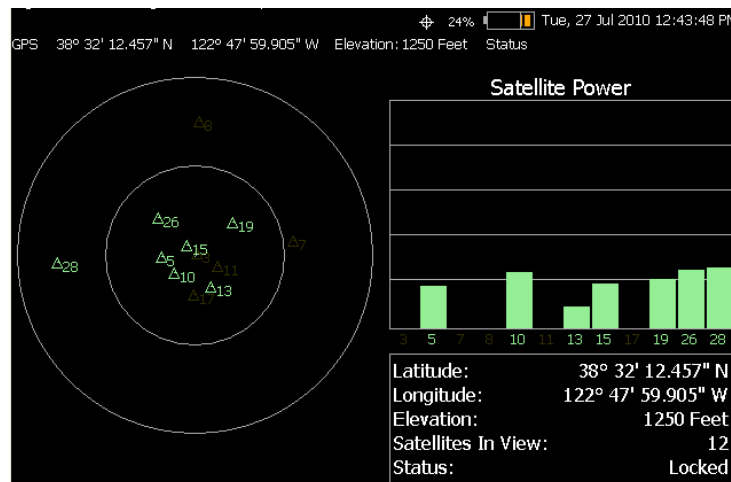

- The left portion of the screen shows satellites and the corresponding number on the adjacent Satellite Power chart.
- **Sync Clock ON OFF** Enable and disable the synchronization of the FieldFox internal clock to the GPS UTC time standard.

NOTE The GPS Sync setting has the same restrictions as the Date and Time setting. Time can be changed BACK no more than once a day and no more than 6 hours at a time. Learn more on page 142.

- **ON** The FieldFox clock is synchronized and updated approximately every second to the time of the GPS clock.

- **OFF** The FieldFox clock is NOT synched with GPS. When set to OFF after Sync was ON, the date and time does NOT revert back to the settings before the clock was synchronized.
- **Display ON OFF** Enable and disable the GPS display on the FieldFox main window.
- **Lat/Lon Format** Change the format of the GPS display on the FieldFox screen. Choose from:
 - **ddd°mm' ss.sss"** degrees, minutes, seconds (default setting)
 - **ddd°mm.mmmmm'** degrees, minutes, fractional minutes
 - **ddd.ddddddd°** decimal degrees
- **Elevation Unit** Choose from:
 - **m** (Meters)
 - **Feet**

GPS Status

With GPS enabled and a device detected, the following is displayed at the top of the FieldFox screen:

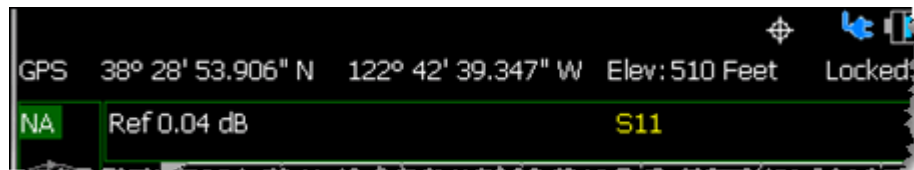

In the above image, the following icons show if the FieldFox is locked on satellites:

- GPS ON and locked on satellites.
- GPS ON, but NOT locked on satellites.
- GPS ON, but no GPS receiver is present or detected.

Saving Data with GPS Enabled

GPS position and clock data are included when data is saved with the following files types: *.csv, *.SnP, State, State+Trace data save.

A warning is shown if the GPS is ON but unlocked at time of save, or if the GPS feature is ON but no GPS is physically present at time of save.

The following is a sample S1P file with GPS information:

```
!GPS Latitude: 38 28.87717 N
!GPS Longitude: 122 42.66625 W
!GPS TimeStamp: 06/25/2010 16:24:48
!GPS Seconds Since Last Read: 2
```

Frequency Reference Source

The FieldFox can phase lock with an external 10 MHz reference signal. When a high-stability 10 MHz reference signal is available, this can improve the accuracy and stability of measurements in CAT and NA Modes.

The External Reference setting will survive a FieldFox or Mode Preset and is saved as part of the Instrument State.

How to use an External Reference

Connect the 10 MHz External Reference to the **EXT TRIG/EXT REF** BNC connector on the FieldFox top panel. External Triggering is NOT available on the N9923A.

- Press **System 7**
- Then **System Configuration**
- Then **Frequency Ref**
- Then **Freq Ref Source Int Ext**

NOTE The FieldFox may take up to 10 seconds to lock to a valid External Reference source.

When switched to Ext, if the FieldFox does NOT find an appropriate signal with which it can lock, then **Ext Ref UNLOCKED** is displayed in the lower-left corner of the screen. This can occur when any of the following conditions exist:

- NO external reference signal is present.
- A low-level external reference signal is present.
- A very high-level external reference signal is present.
- The external reference is off-frequency.

For best results, the signal should be between -5 dBm and +5 dBm.

Security Level

For security reasons, you can prevent frequency information from appearing on the FieldFox while in NA or CAT modes.

How to set Security Level

- Press **System 7**
- Then **System Configuration**
- Then **Security Level**
- Then choose from the following:
 - **None** All frequency settings are visible.
 - **High** Frequency information is blanked from the following:
 - Display annotation
 - Softkeys
 - Marker display and marker table
 - Calibration properties
 - All settings tables
 - Limit line tables
 - All saved .png files
 - Any of the following will re-display frequency information:
 - Set to **None**, Preset, Mode Preset, or FieldFox restart.

Date and Time, Format, and Time Zone Settings

Set the local Date and Time, Date and Time format, and Time Zone that is shown on the FieldFox screen. The Date and Time is also used to identify files that are saved.

The Date and Time can also be set by synchronizing with GPS satellites. Learn more on page 139.

How to Update Date and Time using Internet

This method of setting the Date and Time does NOT have the security restrictions of the other methods (listed below).

This method will NOT set the correct Time Zone. You must do that using the manual method. See below.

- Press **System 7**
- Then **System Configuration**.
- Then **More**
- Then **Update Time using Internet**
- Connect a LAN cable that is also connected to the internet.
- Then press **Update Time using Internet**. When successful, a message is displayed indicating the amount of time correction that occurred.
- Optional: Set the following when a Proxy server is used to connect to the internet:
 - **Proxy Host** – Enter the name of the proxy host.
 - **Proxy Port** – Enter the port number of the proxy host.

How to MANUALLY set Date and Time, Date and Time Format, and Time Zone

NOTE

Because of licensing security, the MANUAL Date and Time setting is restricted as follows:

- Can be set backward no more than 5 hours at a time.
- Can be set forward any amount of time.
- Can be set backward or forward no more than once in a day. A new day begins at midnight.
- The GPS Sync setting has the same restrictions.
- There is no restriction for setting the Time Zone.

To change the Date and Time backward a significant amount, send an email to ctd-soco_support@keysight.com.

TIP

BEFORE manually setting the Date and Time, be absolutely certain that the Time Zone setting is correct.

- Press **System 7**.
- Then **System Configuration**.
- Then **Date and Time**.
- Press the **▲|▼** arrows to highlight the row to be edited.
- Then **Edit**.
- Use the rotary knob to highlight the field to be edited.

- Use the **▲|▼** arrows or numeric keypad to edit that field.
- Press **Cancel** or **Done** when the edits are complete.
- Press **Done** to exit the Date and Time settings. The readout in the upper-right corner of the FieldFox screen will update accordingly.

LAN Settings

Configure the LAN settings to be used to communicate with the Data Link Software. Learn more at: www.keysight.com/find/fieldfoxsupport

Use knob. Press [Edit] to make changes. Press [Done] to exit.	
Setting	Value
Current IP Address	192.168.1.102
Current Subnet Mask	255.255.255.0
Current Gateway	192.168.1.1
Hostname	A-N9912A-00000
Obtain IP Address using:	DHCP
Static IP Address	123.456.789.123.123
Static Subnet Mask	0.0.0.0
Static Gateway	0.0.0.0
Apply Settings at:	PowerUp

LAN Settings

How to configure the LAN settings

The first three 'Current...' settings can NOT be edited.

- Press **System 7**.
- Then **System Configuration**.
- Then **LAN**.
- Use the **▲|▼** arrows to select one of the following, then press **Edit**.
 - **Hostname** Change the name that can be used to address the FieldFox if your server supports this feature. The default hostname is generated automatically.
 - **Obtain IP** Choose from:
 - **DHCP** - IP Address is assigned dynamically. If your server supports this feature, the IP Address for the FieldFox is assigned each time it is started.
 - **Static** - Set the IP Address manually. The Address remains until you change it.
 - **Static IP Address** - Enter the IP Address – including periods - in the format nnn.nnn.nnn.nnn
 - **Static Subnet Mask** - Enter the Subnet Mask – including periods - in the format nnn.nnn.nnn.nnn
 - **Static Gateway** - Enter the Static Gateway – including periods - in the format nnn.nnn.nnn.nnn
 - **Apply Settings** Choose from:
 - **Power Up** The above settings take effect when the FieldFox is started.
 - **Now** The above settings take effect immediately.

NOTE To make the LAN settings persist after power up, toggle **Apply Settings** to **Now** then back to **Power Up**. You should see a message indicating that the LANconfig file was saved.

- Press **Done Edit** when finished.

Power ON

When the FieldFox is without a power source, this setting allows the FieldFox to power ON as soon as a charged battery or the DC Adapter is inserted without pressing the power button.

How to set Power ON

- Press **System 7**
- Then **System Configuration**
- Then **Power ON**
- Then choose from the following:
 - **Auto** The FieldFox will power ON when a charged battery or the DC Adapter is inserted.
- **Manual** The FieldFox will power ON only when the power button is pressed.

Service Diagnostics

- The Service diagnostics menu is generally used to display service-related information. To access these menu items, press **System 7** then **Service Diagnostics**.

System Information

The System information table shows important information about your FieldFox. The following is the most useful information:

- **Model Number** – FieldFox model
- **Serial Number** – Identification number of your FieldFox
- **Firmware Release** – The currently installed version of software. Check to see if you have the latest firmware at: www.keysight.com/find/fieldfoxsupport
- **Network Identity** – The network name and current IP address of your FieldFox.
- **Reflectometer Cal** – The Factory (CalReady) Calibration shows the date and time that the factory cal was performed for each test port and the Thru connection. The format is P1 <date time>, P2 <date time>, P1-P2 <date time>. The factory calibration is updated when you send your FieldFox to Keysight for Instrument Calibration. Learn more on page 163.

Error Log

The Error Log shows the information that has appeared on the FieldFox screen. The most recent information is at the top of the table.

Press **Clear Errors** to erase this information.

Battery

Learn about this table on page 146.

Internal Temperatures

Learn all about this table and the importance of the internal FieldFox temperatures on page 14.

Erase User Data

All data that you have written to the FieldFox can be erased with the press of a button. You would do this if your FieldFox is located in a secure environment and must be routinely erased of sensitive data.

All data is deleted from the FieldFox internal "UserData" partition. This includes all State files and Trace + State files (*.sta), all Data files (*.csv, *.snp), all Picture files (*.png), all Cal Kit files, and all Cable files.

External media that is inserted (mini-SD card or USB flash drive) is NOT erased.

The "Lost Clusters" folder and files is NOT erased because it is part of the file system housekeeping.

How to Erase User Data

- Press **System 7**.
- Then **Service Diagnostics**.
- Then **Advanced**.
- Then **Erase User Data**.
- Then **Confirm Erase**.
- Then the following occurs:
 - All data files and folders are deleted from the "UserData" partition.
 - A large file of 0s is written to all of the free blocks on the partition.
 - The large file is deleted. All blocks released by deleting this file are now available for use.

The FieldFox is rebooted, which manages the newly-freed data and re-writes the factory cal kits and cable files.

Debug Value

Used by Keysight Service Personnel only.

Working with the Lithium-Ion Battery

In this Chapter

- Viewing Battery Charge Status 146
- Charging the Battery 146
- Reconditioning the Battery..... 149
- Battery Care 149
- Maximizing Battery Life 150
- Battery Disposal..... 151

See Also



- Installing the Battery 12
- Conserving Battery Power 12
- Battery Safety Considerations 155

Viewing Battery Charge Status

You can view the battery charge status in the following ways:

- Icons in the upper right of the front panel screen.
- Battery screen - select **System** then **Service Diagnostics** then **Battery**.
- Built-in battery gauge. Learn more in the following section.

Front Panel Icons

Icon	Status
	Connected to external power through the AC/DC adapter. Battery installed and charging. The amount of charge is indicated by the number of bars shown.
	Battery not charging with 84% battery life remaining.
	Battery fully charged. A fully charged battery MAY NOT read 100%. Learn more on page 149, Reconditioning the Battery.

Service Diagnostics – Battery Screen

The Battery screen displays the following information. To access the screen, select **System** then **Service Diagnostics** then **Battery**.

Additional battery information is available using SCPI commands.

1. **Status** – Fully charged, No battery, Charging, Empty, or Discharging.
2. **External DC Supply** – True or False indicates if an external DC supply is connected.
3. **Battery Present** – True or False indicates if a battery is installed.

NOTE Items 4 through 8 are read directly from the battery. The information is based on the battery's internal sensors and memory.

4. **Voltage** – measured by the battery's sensor.

5. **Current** – amount of current being consumed when operating from internal battery. If battery is charging, indicates amount of charging current.
6. **Battery Temperature** – internal temperature of the battery as measured by a sensor embedded in the battery.
7. **Present Run Time to Empty** – minutes of power remaining based on amount of current being used now.
8. **Charge Cycles** – number of charge cycles the battery has experienced. Charge cycle defined as $\geq 80\%$ change in relative state of charge.

Built-In Battery Gauge

Each lithium ion battery has an LED gauge that displays its charge status. The gauge is active unless the battery is in shutdown mode.

To view the LED gauge, open the FieldFox battery compartment door, remove the battery, then press the button on the battery.

The battery in your FieldFox will have either 4 or 5 LED segments.

5-segment Gauge	Charge Remaining	4-segment Gauge	Charge Remaining
5 segments	$\geq 80\%$	4 segments	$\geq 75\%$
4 segments	60% to 79%	3 segments	50% to 74%
3 segments	40% to 59%	2 segments	25% to 49%
2 segments	20% to 39%	1 segment	$< 25\%$
1 segment	$< 20\%$		

Charging the Battery

When you receive your FieldFox, the lithium-ion battery is partially charged to approximately 30% to 40% to preserve battery life. Allow four hours to fully charge the battery internally, or three hours by using the external battery charger (N9910X – 872). A fully charged battery will power your FieldFox for about four hours. It is NOT necessary for you to do any type of battery preconditioning before use.

The FieldFox circuitry ALWAYS prevents the battery from discharging to a level that is damaging. However, if the battery is **completely** discharged, the FieldFox may not turn ON. If this occurs, the battery can still be charged either internally or externally.

Because a lithium-ion battery has no memory effect, you can charge a battery at any time regardless of the current charge status. However, this could impair the accuracy of its internal charge-remaining indicator. When the Max Error is greater than 10%, the battery should be reconditioned. Learn more on page 149.

Internal Charging with the AC/DC Adapter

Important: Read the safety information for the AC/DC adapter on page 153.

Internal charging time for a fully depleted battery is approximately 4 hours with the FieldFox either ON or OFF.



AC/DC adapter

To charge a battery inside the FieldFox, insert the AC/DC adapter plug into the Power connector on the FieldFox side panel (middle hinged door), then plug the adapter into an AC outlet.

- FieldFox ON: Charging is indicated by a battery icon in the upper right of the front panel screen. The icon shows 100% when charging is done.
- FieldFox OFF: Charging is indicated by the FieldFox power LED glowing amber, with its intensity increasing from dim to bright every few seconds. This pattern repeats until the LED turns off when charging is done. Learn more on page 16.

Using the External Battery Charger (N9910X-872)

Important: Read the safety information for the External Charger on page 154.



External Battery Charger (N9910X-872)

The external battery charger (N9910X-872), lets you charge a fully depleted battery in approximately three hours. It is a two bay, level-3 stand-alone battery charger that is compliant with the standard Smart Battery System. The two bays are charged sequentially on a first-come, first-served basis, though a discharge can be performed in the left bay while the right bay is charging. It uses an external universal switching power supply

External Battery Charger LED	Charging Status
Green	Fully charged
Green flashing	Fast charging
Yellow flashing	Reconditioning – the accuracy of the battery’s internal LED charge gauge is being renewed. See “Reconditioning Batteries.”
Yellow/green	Battery is reconditioned
Red flashing	Error
Yellow	Standby

For more information, refer to the Instruction Manual included with the external battery charger.

Reconditioning the Battery

The battery contains electronics that monitors battery usage and tracks how much capacity is available. This function can become less accurate because of temperature fluctuations, aging, self-discharge, repeated partial charging, and other factors. Reconditioning – also known as recalibrating – restores the accuracy of the battery capacity tracking system.

Reconditioning does NOT affect actual battery performance. It only recalibrates the charge level indicator.

Reconditioning is done by fully charging the battery, fully discharging it, recharging it again, and then verifying that the error has been corrected.

How to determine if a battery needs reconditioning

1. Press **System** then **Service Diagnostics** then **Battery**.
2. On the Battery screen, if the Max Error is 10% or greater, the battery needs to be reconditioned.
 - This error will affect many of the displayed battery charge indicators.

After reconditioning, if the battery is not fully charged or continues to show more than a 9% Max Error reading, repeat the reconditioning procedure.

If the third reconditioning does not restore a full charge and give an error reading of 9% or less, the battery may need replacement.

You can recondition a battery internally, or with the External Charger (N9910X-872). The external charger process is faster and simpler.

How to perform Internal Reconditioning

1. Fully charge the battery inside the FieldFox (either ON or OFF) using the AC/DC adapter.
2. Confirm that the battery is fully charged. When fully charged, the following icon appears on the FieldFox: 

3. Fully discharge the battery by disconnecting the AC/DC adapter, then leave the FieldFox ON until it shuts down (about four to five hours).
4. Remove the battery from the FieldFox, wait one minute, then re-install the battery.
5. Reconnect the AC/DC adapter.
6. Charge the battery and verify a full charge.
7. Check the **System** then **Service Diagnostics** then **Battery** screen to verify that the Max Error is less than 10%.

How to Recondition with the External Battery Charger (N9910X-872)

1. Insert a battery into the left bay of the external charger.
2. Press the button labeled Push to Recalibrate Left Battery Bay
3. The charger will charge the battery fully, discharge it completely, then recharge it fully again. The entire process can take up to 12 hours.
4. Install the battery into the FieldFox.
5. On the System, Battery screen, verify that the battery is fully charged and reconditioned.

Battery Care

Visually inspect the battery periodically for signs of degradation, such as swelling, cracking of the battery shell, or leakage of fluid. If degradation occurs, replace the battery and dispose of it properly. Learn how on page 151. Operation with a degraded battery could result in damage to the FieldFox. Learn more on page 155.

Maximizing Battery Life

- If AC power is not continuously available (Ex: in a field environment), use the battery and recharge it when it holds a 20% to 50% charge, as shown on the screen's battery charge icon. At this charge level, 2 or 3 segments show on the battery gauge.
- If the FieldFox is not going to be used for more than a week, remove the battery. Best practice is to store the battery with a charge of about 50%. At this charge level, 3 segments show on the battery gauge. Batteries that remain idle eventually lose their ability to hold a charge.
- Allow a battery to warm to room temperature before charging it. Temperature shock can damage the battery chemistry and in some cases cause a short circuit.
- Store batteries in a cool, dry location, away from metal objects and corrosive gases.
Storage temperature limits (20% to 50% relative charge is recommended):
 - Transportation: -20°C to 50°C
 - Within 1 month: -20°C to 45°C
 - Within 6 months: -20°C to 40°C
 - Within 1 year: -20°C to 35°C
- Battery charging limits:
 - Charge temperature: 0°C to 45°C (<10°C slows charge on some batteries)
 - Discharge temperature: -10°C to 60°C

- Operate the FieldFox on battery power between the ambient temperatures of –10 and +50°C (–14 to +122°F). Using the battery at lower or higher temperatures can damage it and reduce operating life. Cold temperatures affect battery chemistry, reducing charge capacity, especially below 0°C (32°F).

Lithium Ion Battery Disposal

When you notice a large decrease in charge capacity after proper recharging, it's probably time to replace the battery.

Lithium-Ion batteries need to be disposed of properly. Contact your local waste management facility for information regarding environmentally sound collection, recycling, and disposal of the batteries. Regulations vary for different countries. Dispose of in accordance with local regulations.

Keysight Technologies, through Rechargeable Battery Recycling Corporation (RBRC), offers free and convenient battery recycling options in the U.S. and Canada. Contact RBRC at 877-2-RECYCLE (877.273.2925) or online at: <http://www.call2recycle.org/> for the nearest recycling location

Safety Considerations

Keysight has designed and tested the FieldFox in accordance with IEC Publication 61010-1:2001 Safety Requirements for Electrical Equipment for Measurement, Control and Laboratory Use, and the FieldFox is supplied in a safe condition. The FieldFox is also designed for use in Installation Category II and pollution Degree 2 per IEC 61010 and IEC 60664 respectively. Read the following safety notices carefully before you start to use this FieldFox to ensure safe operation and to maintain the product in a safe condition.

For the FieldFox

WARNING

No operator serviceable parts inside except for the lithium-ion battery. Refer servicing to qualified personnel. To prevent electrical shock do not remove covers.

WARNING

If this product is not used as specified, the protection provided by the equipment could be impaired. This product must be used in a normal condition (in which all means for protection are intact) when attached to the AC-DC adapter.

WARNING

The unit may be used only in the operating conditions and positions specified by the manufacturer. The Keysight N9923A complies with the following standards

IEC 61010 2nd Edition/EN 61010 2nd Edition

Canada: CSA C22.2 No. 61010-1-04

USA: UL 61010-1 2nd Edition

WARNING

Do not install substitute parts or perform any unauthorized modification to the product. Return the product to Keysight Technologies or a designated repair center for service to ensure that safety features are maintained.

WARNING

Applicable local or national safety regulations and rules for the prevention of accidents must be observed in all work performed.

WARNING

Ensure that the connections with information technology equipment comply with IEC950 / EN60950.

WARNING

Observe all ratings and markings of the instrument before connecting the instrument.

Maximum Input Voltages and Power:

PORT 1 Connector: ± 50 VDC, +23 dBm RF

Ext Trig/Ref Connector: 5.5 V DC

PORT 2 Connector: ± 50 VDC, +23 dBm RF

DC Input: 19VDC, 4ADC

WARNING

When performing a measurement, ensure that the right safety and performance ratings of the instrument and accessories are used.

Do not expose the circuit or operate the instrument without its cover or while power is being supplied.

Do not operate the instrument in any environment at risk of explosion.

CAUTION

The power cord and connectors shall be compatible with the connector used in the premise electrical system. Failure to ensure adequate earth grounding by not using the correct components may cause product damage and serious injury.

CAUTION

The measuring terminals on this instrument are designed to be used with external signals described in Measurement Category I, but NOT with external signals described in Categories.

For the AC/DC Adapter

WARNING

The AC/DC adapter is a Safety Class 1 Product (provided with a protective earthing ground incorporated in the power cord). The mains plug shall only be inserted in a socket outlet provided with a protective earth contact. Any interruption of the protective conductor inside or outside of the product is likely to make the product dangerous. Intentional interruption is prohibited.

WARNING

Use only the designated AC/DC adapter supplied with the instrument.

WARNING

Use only the designated power cord supplied with the AC/DC adapter.

WARNING

No operator serviceable parts inside this product. Do not perform any unauthorized modification to the product. Return the product to Keysight Technologies or a designated repair center for service to ensure that safety features are maintained.

WARNING

Operated at an ambient temperature: 0 to 40°C; full power rating; derate linearly to 50 W at 50°C.

Maximum output rating: +15V/4.0 A.

Input rating: AC 100–240 V, 50/60Hz

WARNING

Main Plug : Use a 3-pin main plug that complies with IEC 60884–1, Plugs and Socket–Outlets for Household and Similar Purposes – Parts1: General Requirements and country specific safety authority requirements, such as UL, SA, BSI, VDE, CCC, SA, NZ, and PSE.

WARNING

Appliance Connector: Use an appliance connector certified to IEC 60320–1/EN 60320–1 requirements

WARNING

To prevent electrical shock, disconnect the AC to DC adapter from the mains before cleaning. Use a dry cloth or one slightly dampened with water to clean the external case parts. Do not attempt to clean internally.

WARNING

When the FieldFox is connected to the AC/DC adapter, position the adapter so the power cord is readily accessible. The power cord is the disconnecting device. It removes main power to the AC/DC adapter. The FieldFox front panel switch is only for the DC power within the instrument, and not for the AC/DC adapter. Alternately, an AC switch or circuit breaker (which is readily identifiable and is easily reached by the operator) may be installed and used as a disconnecting device to remove mains power from the AC/DC adapter.

WARNING

To avoid overheating, always disconnect the FieldFox from the AC/DC adapter before storing the FieldFox in the backpack.

If you prefer to leave the FieldFox connected to the AC/DC adapter while inside the backpack, you can disconnect the AC/DC adapter from its AC power source to prevent overheating.

CAUTION

The AC/DC adapter has an auto-ranging line voltage input – be sure the supply voltage is within the specified range.

CAUTION

The AC/DC adapter is for indoor use only.

CAUTION

Never use a modified or damaged charger. Use the original AC–DC adapter ONLY.

CAUTION

The AC/DC adapter is designed for use in Installation Category II and Pollution Degree 2 per IEC 61010 Second Edition.

For the External Battery Charger (N9910X–872)

CAUTION

If charging batteries externally, use the optional external charger available from Keysight, or another SMBus charger of level II or higher.

Never use a non-SMBus charger because the battery issues commands over the SMBus to the charger to control the charge rate and voltage.

Never use a modified or damaged charger.

For the Battery

Lithium battery packs may get hot, explode, or ignite and cause serious injury if exposed to abuse conditions. Be sure to follow these safety warnings:

WARNING

Lithium-ion batteries:

Must not be exposed to high temperatures (>70°C) or fire.

Must be kept away from children.

Must not be short circuited.

Must be replaced only with Keysight qualified Li-ion batteries.

If replaced or charged improperly, there is a danger of explosion.

WARNING

Do not connect the positive terminal and negative terminal of the battery to each other with any metal object (such as wire).

WARNING

Do not carry or store the battery with necklaces, hairpins, or other metal objects.

WARNING

Do not pierce the battery with nails, strike the battery with a hammer, step on the battery, or otherwise subject it to strong impacts or shocks.

WARNING

Do not solder directly onto the battery.

WARNING

Do not expose the battery to water or salt water, or allow the battery to get wet.

WARNING

Do not disassemble or modify the battery. The battery contains safety and protection devices, which if damaged, may cause the battery to generate heat, explode, or ignite.

WARNING

Do not place the battery in direct sunlight, or use or store the battery inside cars in hot weather. Doing so may cause the battery to generate heat, explode, or ignite. Using the battery in this manner may also result in a loss of performance and a shortened life expectancy.

WARNING

There is a danger of explosion if the battery is incorrectly replaced. Replace only with the same or equivalent type of battery recommended. Discard used batteries according to manufacturer's instructions.

WARNING

If you are charging the batteries internally, even while the FieldFox is powered off, the FieldFox may become warm. Allow for proper ventilation.

WARNING

Do not discharge the battery using any device except the FieldFox or the external battery charger (N9910X-872). When the battery is used in a device other than those specified, it may damage the battery or reduce its life expectancy. If the device causes an abnormal current to flow, it may cause the battery to become hot, explode, or ignite and cause serious injury

Battery Protective Functions

The following protective functions are designed into the lithium-ion rechargeable battery system used in FieldFox.

The protective functions can be divided between two categories: active and passive. Active protection refers to the type of protection that depends on at least two or more protection devices working together to enable the protection. Passive protection refers to the type of protection that is always enabled independent of any other protection device.

Active Protection

Primary Overcharge Voltage: This prevents the battery from being charged if the voltage across any cell exceeds approximately 4.35 V per cell. Once the overcharge protection is tripped, the voltage across each cell must drop below approximately 4.15 V to reset the protection and permit charging.

Secondary Overcharge Voltage: This is a one-time, permanent protection that is triggered when the voltage across any cell exceeds approximately 4.45 V. Once this protection is tripped, the battery can no longer be used and must be replaced.

Overdischarge Voltage: This prevents the battery from discharging if the voltage across any cell drops below approximately 2.6 V. Once the overdischarge voltage protection is tripped, the voltage across each cell must be charged to approximately 3 V to reset the protection and permit discharging.

Primary Overcharge Current: This prevents the battery from being charged if the average charging current reaches or exceeds 3.5A for a time period of 120 seconds or more.

Secondary Overcharge Current: This prevents the battery from being charged if the charging current reaches or exceeds $4A \pm 20\%$ for a time period of 20 milliseconds or more.

Primary Overdischarge Current: This prevents the battery from being discharged if the average current out of the battery reaches or exceeds 5A for a time period of 120 seconds or more. This protection can be reset by removing the load.

Secondary Overdischarge Current: This prevents the battery from being discharged if the current out of the battery reaches or exceeds 6A for a time period of 20 milliseconds or more. This protection can be reset by removing the load.

Short Circuit Protection: This prevents the battery from being charged or discharged and protects against damage or lost data if the current in or out of the battery reaches or exceeds 12.5A for a time period of 183 microseconds or more. This protection can be reset by removing the load.

Overtemperature Charging: The system microcontroller prevents the battery from being charged if the cell temperature exceeds 46C. Once the overtemperature charging protection is tripped, the cell temperature has to drop to or below 45C to reset the protection and permit charging.

Overtemperature Discharging: The system microcontroller prevents the battery from being discharged if the cell temperature exceeds 65C. Once the overtemperature discharging protection is tripped, the battery is automatically shut off which results in turning off the instrument as well.

Passive Protection

Reverse Charging: A reverse protection diode prevents against damage or lost data due to a reverse charge polarity applied to the battery terminals.

Primary Overtemperature: A PTC(positive temperature coefficient) polyfuse in series between the Li-ion cells and the charging and discharging transistors will open up and limit current flow to the battery terminals as a function of very high temperatures. This protection is resettable once the overstress condition is removed. The maximum operating temperature of this fuse is 85C.

Secondary Overtemperature: A second PTC polyfuse built into each Li-ion cell will open up and limit current flow as a function of very high temperatures.

Tertiary Overtemperature: A current interrupt device (CID) within each Li-ion cell will permanently open up when the temperature reaches 95C. As each cell fuse is permanently interrupted, overall battery performance will become severely degraded, up to and including disabling the battery.

Overcurrent Fuse: This is a one-time blow fuse with a rated current of 12A.

Batteries: Safe Handling and Disposal

To learn how to safely handle and dispose of the FieldFox battery, refer to the Material Safety Data Sheet for the manufacturer of the battery at:

<http://na.support.keysight.com/fieldfox/help/Reference/MSDS.htm>

Environmental Requirements

Refer to the Specifications section of this document.

Electrical Requirements

The FieldFox allows you to use either the lithium-ion battery or the AC/DC adapter - both are included.

Electrostatic Discharge (ESD) Precautions

The FieldFox was constructed in an ESD protected environment. This is because most of the semiconductor devices used in this instrument are susceptible to damage by static discharge.

Static charges are generated in numerous ways, such as simple contact, separation of materials, and normal motions of persons working with the FieldFox. To prevent instrument damage, practice industry accepted techniques for handling static sensitive devices when using the FieldFox.

Very often, coaxial cables and antennas also build up a static charge, which, if allowed to discharge by connecting to the FieldFox, may damage the instrument input circuitry. To avoid such damage, it is recommended to dissipate any static charges by temporarily attaching a short to the cable or antenna prior to attaching to the instrument.

FieldFox Markings



The CSA mark is a registered trademark of CSA International.



The RCM Mark is a registered trademark of the Australian Communications and Media Authority.



This symbol combines the following three markings:

CE indicates product compliance with all relevant European legal Directives (if accompanied by a year, it signifies when the design was proven).

ICES indicates product compliance with the Canadian Interference-Causing Equipment Standard (ICES-001).

ISM indicates this is an Industrial Scientific and Medical Group 1 Class B product (CISPR 11, Clause 4)



The Korean Certification (KC) mark is required for products that are subject to legally compulsory certification. The KC mark includes the marking's identifier code that has up to 26 digits and follows this format: KCC-VWX-YYY-ZZZZZZZZZZZZ



The standby symbol is used to mark a position of the instrument power line switch.



This symbol indicates separate collection for electrical and electronic equipment, mandated under EU law as of August 13, 2005. All electric and electronic equipment are required to be separated from normal waste for disposal (Reference WEEE Directive, 2002/96/EC).



Indicates the time period which no hazardous or toxic substance elements are expected to leak or deteriorate during normal use. Forty years is the expected useful life of the product.



CAUTION, risk of danger, refer to safety information in manual.



Dispose of properly



Hot surface - connectors get hot during extended operation, so care must be taken when making connections and disconnections.

Battery Markings



The CE mark shows that the product complies with all relevant European legal Directives (if accompanied by a year, it signifies when the design was proven).



The battery parts can be recycled. Consult local or country regulations.



Dispose of properly. Do not throw batteries away – collect as small chemical waste.



Recycle the old battery properly. Consult local or country regulations related to disposal.



Keep battery away from excessive heat. Do not dispose of by burning.



UL recognized in Canada and the United States.

Packaging Markings



This symbol on all primary and secondary packaging indicates compliance to China standard GB 18455-2001.

AC/DC Adapter Markings



The UL Marks are registered certification marks of Underwriters Laboratories Inc. (UL). It means that UL has tested and evaluated representative samples of that product and determined that it meets UL's safety requirements. When accompanied by a 'C' and 'US', it indicates compliance to both Canadian and US requirements.



NOM Mark (Normality of Mexico) indicates that the product was tested by an accredited laboratory in Mexico and meets Mexico's safety requirements.



Japan's safety and EMC compliance mark.



China's safety and EMC compliance mark.



Taiwan's safety and EMC compliance mark.



Singapore's safety mark.



Korea's safety and EMC mark.



GOST, Russia's safety and EMC mark.



AC (Alternating Current).



Direct current (DC) equipment



CAUTION, risk of danger, refer to safety information in manual.



DC connector polarity



Dispose of properly

Certification and Compliance Statements

Certification

Keysight Technologies, Inc. certifies that this product met its published specifications at the time of shipment from the factory. Keysight Technologies, Inc. further certifies that its calibration measurements are traceable to the United States National Institute of Standards and Technology, to the extent allowed by the Institute's calibration facility, and to the calibration facilities of other International Standards Organization members.

Manufacturer's Declaration

This product has been designed and tested in accordance with accepted industry standards, and has been supplied in a safe condition. The documentation contains information and warnings that must be followed by the user to ensure safe operation and to maintain the product in a safe condition.

Declaration of Conformity

Should the Declaration of Conformity be required, visit:

<http://www.keysight.com/go/conformity>

For more information, see Contacting Keysight on page 2.

Compliance with German Noise Requirements

This is to declare that this instrument is in conformance with the German Regulation on Noise Declaration for Machines (Laermangabe nach der Maschinenlaermrrordnung -3. GSGV Deutschland).

Acoustic Noise Emission	Geraeuschemission
LpA <70 dB	LpA <70 dB
Operator position	am Arbeitsplatz
Normal position	normaler Betrieb
per ISO 7779	nach DIN 45635 t.19

Compliance with Canadian EMC Requirements

This ISM device complies with Canadian ICES-001.

Cet appareil ISM est conforme a la norme NMB du Canada.

South Korean Class A EMC declaration

This equipment is Class A suitable for professional use and is for use in electromagnetic environments outside of the home.

A급 기기

(업무용 방송통신기자재)

이 기기는 업무용(A급) 전자파적합기기로서 판매자 또는 사용자는 이 점을 주의하시기 바라며, 가정외의 지역에서 사용하는 것을 목적으로 합니다.

Appendix A: Connector Care Review

Proper connector care and connection techniques are critical for accurate and repeatable measurements. The following table contains tips on connector care.

Prior to making connections to your analyzer, carefully review the information about inspecting, cleaning, and gauging connectors. For course numbers about additional connector care instruction, contact Keysight Technologies.

Handling and Storage

Do

- Keep connectors clean
- Extend sleeve or connector nut
- Use plastic end-caps during storage

Do Not

- Touch mating-plane surfaces
- Set connectors contact-end down
- Store connectors or adapters loose

Visual Inspection

Do

- Inspect all connectors carefully
- Look for metal particles, scratches, and dents

Do Not

- Use a damaged connector - ever

Connector Cleaning

Do

- Try compressed air first
- Use isopropyl alcohol ^a
- Clean connector threads

Do Not

- Use any abrasives
- Get liquid into plastic support beads

Gauging Connectors

Do

- Clean and zero the gage before use
- Use the correct gage type
- Use correct end of calibration block
- Gage all connectors before first use

Do Not

- Use an out-of-specification connector

Making Connections

Do

- Align connectors carefully
- Make preliminary connection contact lightly
- Turn only the connector nut
- Use a torque wrench for final connection

Do Not

- Apply bending force to connection
- Over tighten preliminary connection
- Twist or screw any connection
- Tighten past torque wrench “break” point

^aCleaning connectors with alcohol shall only be done with the DC power cord removed, in a well-ventilated area, and with the power to the FieldFox turned OFF. Allow all residual alcohol moisture to evaporate, and the fumes to dissipate prior to energizing the instrument.

Appendix B: Specifications/Data Sheet

To ensure the highest accuracy and consistency, the N9923A Specifications are stored ONLY at: <http://literature.cdn.keysight.com/litweb/pdf/5990-5363EN.pdf>

Appendix C: Instrument Calibration

Over time, the active components in the FieldFox age and the performance may degrade or drift. To ensure that the FieldFox is performing to the published specifications, you should have an instrument calibration performed periodically.

How Often Should I Get an Instrument Calibrated?

You determine the calibration period which best meets your requirements. However, a 12 month calibration cycle is appropriate for most users.

There are two things to consider: performance drift and connector wear.

The instrument specifications are set to consider the performance drift that may occur over a 12 month period. Therefore, getting the instrument calibrated at 12 month intervals ensures that the analyzer maintains performance within the operating specifications. If you need the analyzer to maintain more consistent operation, you may want to have the instrument calibrated more often.

Connector wear is a bigger factor and depends on the number of connections that are made. The test ports become noticeably worn after 500 to 700 connections. This could represent about 12 months with average use. With more frequent connections, the calibration cycle should be sooner. You can extend the time between calibrations and thereby save money by using connector savers and by performing proper **Connector Care**. Learn more on page 159.

How Do I Get an Instrument Calibrated?

To get the instrument calibrated, send it to one of the Keysight Technologies service centers. Please visit this website to learn how: www.keysight.com/find/calibration.

What Are My Choices of Instrument Calibration?

The following types of instrument calibration are available from Keysight Technologies service center:

Keysight Calibration	Includes the test data from the calibration and the certificate of calibration, stating the instrument has been calibrated and is operating within the published specifications.
ANSI Z540 Calibration	Includes the test data from the calibration and the certificate of calibration, stating the instrument has been calibrated using a process in compliance with ANSI Z540.1 and is operating within the published specifications.
ISO 17025 Calibration	Includes the test data from the calibration and the certificate of calibration, stating the instrument has been calibrated using a process in compliance with ISO 17025 and is operating within the published specifications.

Index

1

- 1-port cable loss measurements
 - CAT mode, 51
- 1-port cable trimming measurements, VVM mode, 107

2

- 2-port insertion loss measurements
 - CAT mode, 52
- 2-port transmission measurements, VVM mode, 108

A

- AC/DC adapter
 - markings, 159
 - power requirements, 11
 - using, 147
- accessories, 9
- Alias Faults, 61
- all about markers, 110
- all about trace math, 122
- appendix B, 161
- averaging, 47
- Averaging, 29
 - VVM, 105
- avoid overpowering, 14

B

- bandpass mode, 56
- battery
 - care, 150
 - charge status, viewing, 146
 - charging, 13
 - external, 148
 - internal, 147
 - disposal, 151
 - gauge, 147
 - installing, 12
 - LED, 149
 - markings, 158
 - maximizing life, 13, 150
 - protective functions, 156
 - reconditioning
 - external, 150
 - internal, 149
 - safe handling, 157
 - service diagnostics, 146
 - viewing charge status, 12
- Battery Saver, 137

- Big Marker IStates, 33
- bridge cancellation measurements, VVM mode, 108
- brightness, display, 133

C

- cable and antenna test. See CAT
- Cable Editing
 - DTF, 57
- cable loss measurements, 51
- Cal On ?, 75
- Calculated DTF values, 60
- calibration
 - Cal On ?, 75
 - CAT and NA modes, 62
 - verifying integrity, 76
- Calibration Type, 71
- CalReady, 63
- CalReady Properties, 75
- care of the battery, 150
- CAT mode
 - 1-port cable loss measurements, 51
 - 2-port insertion loss measurements, 52
 - calibration, 62
 - DTF measurements, 54
 - return loss measurements, 51
 - settings, 45
- certification statements, 159
- charge status, viewing, 146
- charging the battery
 - externally, 148
 - internally, 147
- Clean Screen, 16
- colors, display, 134
- compliance statements, 159
- connector care review, 161
- considerations, safety, 152
- Contacting Keysight, 2
- control, temperature, 14
- Coupled Frequency, 50, 54, 57
- Coupled Markers, 112
- cursor, moving, 129

D

- data analysis features, 110
- declaration of conformity, 160
- delta marker, 112
- display
 - brightness, 133
 - clean, 16
 - colors, 134

- front panel, 18
 - settings, 133
- Display Resolution
 - VVM, 104
- disposal of battery, 151
- dissipate static charge, 14
- distance to fault. See DTF
- distance, start and stop, 56
- DTF
 - measurements, 54
- Dynamic Range, 35

E

- ECal, 68
- Electrical Delay, 28
- Enhanced Response Optimization, 74
- Erase User Data, 145
- error
 - max, 147, 149
 - red flashing LED, external battery charger, 149
 - systematic, 62
- ESD, 157
- external zeroing, 80

F

- features
 - overview, 8
- features, data analysis, 110
- file management, 124
- files
 - managing, 128
 - prefixes, 129
 - saving and recalling, 124
- folders, 128
- Format, 26
- frequency
 - range, setting, 46
- Frequency Offset using Power Sensor, 85
- Frequency Range
 - CAT mode, 46
 - NA mode, 27
- Frequency Reference Source, 140
- front panel, 16

G

- Gating, 41
- gauge, battery, 147
- getting started information, 11
- GPS, 139

group delay, 26

H

high-temperature protection, 14

hold, 131

how to

add or edit a title, 135

change

units to feet, 60

create

delta marker, 112

limit lines, 120

markers, 110

determine if a battery needs

reconditioning, 149

display "live" and memory traces,

122

edit keywords, 129

edit, enable and disable the current

prefix, 129

enter

numeric values, 19

make

1-port cable loss measurement,
51

1-port cable trimming
measurement, 107

2-port insertion loss
measurement, 52

2-Port transmission
measurement, 108

manage files, 128

manage folders, 128

measure return loss, 51

monitor the internal FieldFox

temperature, 14

move

cursor, 125, 130

marker, 111

reference marker, 112

name files, 125

perform

external battery reconditioning,
150

internal reconditioning, 149

normalization, 70

QuickCal, 65

single sweep while in Hold, 132

trace math, 122

preset, 132

recall an *.sta file, 126

recondition battery with external

battery charger, 150

save

file, 124

save and recall limits, 121

select

NA formats, 26

NA mode, 21

VVM measurements, 103

VVM mode, 103

Windows settings, 60

zeroing, 106

set

bandpass mode ON, 56

display colors, 134

frequency range, 46

full screen mode, 135

interference rejection, 50

limit options, 121

output power, 31

resolution, 48

scale, 47

start and stop distance, 56

sweep time, 49

sweep type, 30, 48, 106

trace averaging, 48

use

marker search functions, 114

view and change Quick Settings, 25,

46

I

IF Bandwidth, 29

VVM, 104

initial use, preparing for, 11

input voltages and power, maximum,

14

insertion loss measurements, 52

installing

battery, 12

interference rejection, 50

Interference Rejection

CAT mode, 50

Interpolation, 75

Isolation, 72

K

keywords, 128

L

LAN Settings, 143

language, settings, 136

latest information, where to find, 2

LED

battery, 149

on/off settings, 13, 16

Licensing, 138

limit lines

saving and recalling, 121

setting, 121

Limit Lines, 118

lithium-ion battery

installing, 12

M

managing

files, 128

folders, 128

manuals, 9

markers

creating, 110

delta, 111

moving, 111

table, 112

trace, 113

markings

AC/DC adapter, 159

battery, 158

FieldFox, 157

packaging, 158

math

operations, 123

maximizing battery life, 150

maximum input voltages and power, 14

measurements

1-port cable loss, CAT mode, 51

1-port cable trimming, VVM mode,
107

2-port insertion loss, CAT mode, 52

2-port transmission, VVM mode,
108

bridge cancellation, VVM mode, 108

distance to fault (DTF)

CAT mode, 54

return loss, CAT mode, 51

selection, 45

Mechanical Cal, 66

Mixed-Mode S-Parameters, 22

mode

NA, 20

power meter, 78

temperature control, 14

VVM, 102

moving the cursor, 129

multipliers, 19

Multi-Trace Configurations, 23

N

NA Factory Cal, 144

NA mode

calibration, 62

settings, 21, 23

network analyzer, 20

normalization, 70

numeric values, 19

O

- O, S, L cal, 66
- on/off settings, 13
- Opt 010, 36
- options
 - and features, 8
 - installing, 138
- output power, 31
- Output Power
 - NA Mode, 31, 104
- Output Power CAT Mode, 49
- overpowering, avoid, 14
- overview, 8

P

- packaging markings, 158
- panel
 - front, 16
 - side, 17
- Parameter Conversion, 22
- peak
 - criteria, 117
 - excursion, 117
 - threshold, 117
- Phase Offset, 28
- Port Extensions, 32
- power meter mode, 78
- power requirements for the AC/DC adapter, 11
- power sensor input, 14
- Power Sensors, 78
- power, maximum, 14
- Preferences, 135
- prefixes for file names, 129
- preparing for initial use, 11
- preset settings, 132
- Printing, 130
- protection, high temperature, 14
- protective functions of the battery, 156
- Pulse Measurements, 91

Q

- Quick Settings, 25, 46
 - CAT mode, 46
 - NA mode, 25
- QuickCal, 64

R

- recalling files, 124, 125

- Receiver Measurements, 23
- reconditioning the battery
 - externally, 150
 - internally, 149
- reference marker, 112
- Resolution
 - CAT mode, 48
 - NA mode, 30
- Response Cals, 69
- return loss
 - measurements, CAT mode, 51
- reviewconnector care, 161
- run/hold, 131

S

- S11 measurements, NA mode, 21, 23
- safety considerations, 152
- Save Preferences, 136
- saving files, 124
- Scale Settings
 - CAT mode, 47
 - NA mode, 27
- scale, setting, 47
- Screen cleaning, 16
- screen, front panel, 18
- Security Level, 141
- service
 - diagnostics, 146
- settings
 - display, 133
 - NA mode, 21
 - on/off, 13
 - preset, 132
 - VVM mode, 103
 - windows, 60
- side panel, 17
- Smoothing, 30
- Source Control with USB Power Meter, 80
- S-parameters, 21
- Specifications/Data Sheet, 162
- stand-by mode, 13
- start and stop distance, 56
- Startup Mode, 137
- static charge, dissipate, 14
- Step Detection Mode, 83
- sweep
 - time, 49
 - type, 30, 48, 106
- Sweep Time
 - CAT mode, 49
 - NA mode, 31
- system configuration settings, 138

- System Impedance (Z0), 32
- system settings, 131

T

- temperature control mode, 14
- Time Domain, 36
- Time Zone, 142
- title, editing, 135
- trace averaging, setting, 48
- trace math, 122
- Trace Width, 134
- Transform, 36
- Transform Window, 39
- TRL, 72

U

- units, changing, 60
- USB keyboard, 9

V

- values
 - multipliers, 19
 - numeric, 19
- vector voltmeter, 102
- Velocity Factor, 33
- verifying integrity of calibration, 76
 - jumper cables, 76
- viewing
 - charge status, battery, 146
- Volume Control, 133
- VVM Calibration, 106
- VVM mode
 - 1-port cable trimming measurements, 107
 - 2-port transmission measurements, 108
 - bridge cancellation measurements, 108
 - settings, 103

W

- Waveguide Calibrations, 73
- where to find the latest information, 2
- windows settings, 60



This information is subject to change without notice.
© Keysight Technologies 2014

Print Date: October 1, 2014
Supersedes: May 23, 2014



N9923-90001
www.keysight.com